

INDEX

SL No	Subject	Page No
1.	General Service Knowledge	09-31
2.	Air Campaigns	32-44
3.	Aircraft Recognition	45-67
4.	Modern Trends	68-73
5.	Principles of Flight	74-104
6.	Airmanship	105-147
7.	Navigation	148-161
8.	Meteorology	162-181
9.	Aero Engines	182-198
10.	Airframe	199-215
11.	Instruments	216-227
12.	Aircraft Particulars	228-234
13.	Aero Modeling	235-246

CHAPTER - I			
General Service Knowledge			
Sl No	Code	Subject	Page No
1	GSK-1	Development of Aviation	10-14
2	GSK-2	History of IAF	15-18
3	GSK-3	Organisation of IAF	19-22
4	GSK-4	Branches of the IAF	23-24
5	GSK-5	Modes of Entry in the IAF	25-27
6	GSK-6	Career in the IAF as an Officer/ Airman	28-31
CHAPTER - II			
Air Campaigns (AC)			
Sl No	Code	Subject	Page No
1	AC -1	Indo Pak War 1971	33-36
2	AC -2	Op Safed Sagar	37-39
3	AC -3	Famous Air Heroes	40-43
4	AC -4	Motivational Movies	44
CHAPTER - III			
Aircraft Recognition (ACR)			
Sl No	Code	Subject	Page No
1	AC R-1	Fighters	46-51
2	ACR -2	Transports	52-57
3	AC R-3	Helicopters	58-62
4	ACR -4	Foreign Aircraft	63-67
CHAPTER - IV			
Modern Trends (MT)			
Sl No	Code	Subject	Page No
1	MT-1	Modern Trends	69-73
CHAPTER - V			
Principles of Flight (PF)			
Sl No	Code	Subject	Page No
1	PF-1	Introduction	75-76
2	PF-2	Laws of Motion	77-80
3	PF-3	Glossary of Terms	81-83
4	PF-4	Bernoulli's Theorem and Venturi Effect	84-86
5	PF-5	Aerofoil	87-89
6	PF-6	Forces on an Aircraft	90-91
7	PF-7	Lift & Drag	92-93
8	PF-8	Flaps & Slats	94-97
9	PF-9	Stalling	98-100
10	PF-10	Thrust	101-104
CHAPTER - VI			
Airmanship (AR)			
Sl No	Code	Subject	Page No
1	AR-1	Introduction	106-110
2	AR-2	Airfield Layout	111-115
3	AR-3	Rules of the Air	116-122

4	AR-4	Circuit Procedure	123-126
5	AR-5	ATC / RT Procedure	127-133
6	AR-6	Aviation Medicine	134-139
7	AR-7	Survival	140-147
CHAPTER - VII			
Navigation (NV)			
Sl No	Code	Subject	Page No
1	NV-1	Requirement of Navigation	149-151
2	NV-2	Glossary of Terms	152-154
3	NV-3	Maps	155-158
4	NV-4	Map Reading	159-161
CHAPTER - VIII			
Meteorology (MET)			
Sl No	Code	Subject	Page No
1	MT-1	Important of Met in Aviation	163-165
2	MT-2	Atmosphere	166-169
3	MT-3	Clouds and Precipitation	170-174
4	MT-4	Visibility	175-178
5	MT-5	Humidity and Condensation	179-181
CHAPTER - IX			
Aero – Engines (AE)			
Sl No	Code	Subject	Page No
1	AE-1	Introduction of Aeroengines	183-185
2	AE-2	Types of Engines	186-188
3	AE-3	Piston Engines	189-191
4	AE-4	Jet Engines	192-194
5	AE-5	Turboprop Engines	195-197
6	AE-6	Consolidation	198
CHAPTER -X			
Airframe (AF)			
Sl No	Code	Subject	Page No
1	AF -1	Aircraft Controls	200-203
2	AF -2	Fuselage	204-206
3	AF -3	Main & Tail Plane	207-209
4	AF -4	Ailerons, Elevators & Rudder	210-212
5	AF -5	Landing Gear	213-215
CHAPTER -XI			
Instruments (IN)			
Sl No	Code	Subject	Page No
1	IN-1	Basic Flight Instruments	217-221
2	IN-2	Introduction of Radar	222-224
3	IN-3	Instrument Battery Test (intro to PABT)	225-227
CHAPTER -XII			
Aircraft Particulars (AP)			
Sl No	Code	Subject	Page No
1	AP-1	Aircraft Particulars (Type Specific)	229-234

CHAPTER -XIII			
Aero-modelling (AM)			
Sl No	Code	Subject	Page No
1	AE-1	History of Aero modeling	236-237
2	AE-2	Materials used in Aero modeling	238-239
3	AE-3	Types of Aero models	240-241
4	AE-4	Flying / Building of Aero models	242-246

SPECIALISED SYLLABUS – SD
5. Principles of Flight (PF)

Ser No	Code	Subject	1st yr	Type	2nd yr	Type	3rd yr	Type	Total periods
1	PF-1	Introduction	1	L					1
2	PF-2	Laws of Motion	1	L					1
3	PF-3	Glossary of Terms	1	L					1
4	PF-4	Bernoulli's Theorem and Venturi Effect			1	L			1
5	PF-5	Aerofoil			1	L			1
6	PF-6	Forces on an Aircraft			1	L			1
7	PF-7	Lift & Drag			1	L			1
8	PF-8	Flaps & Slats					1	L	1
9	PF-9	Stalling					1	L	1
10	PF-10	Thrust					1	L	1
		Total	3		4		3		10

6. AIRMANSHIP (AR)

Ser No	Code	Subject	1st yr	Type	2nd yr	Type	3rd yr	Type	Total periods
1	AR-1	Introduction	1	L					1
2	AR-2	Airfield Layout	1	L					1
3	AR-3	Rules of the Air	1	L					1
4	AR-4	Circuit Procedure	1	L					1
5	AR-5	ATC / RT Procedure	1	L	1	P			2
6	AR-6	Aviation Medicine	1	L/P	1	L,F			2
7	AR-7	Survival					2	L,F	2
		Total	6		2		2		10

SPECIALISED SYLLABUS – SD

7. NAVIGATION (NV)

Ser No	Code	Subject	1st yr	Type	2nd yr	Type	3rd yr	Type	Total periods
1	NV-1	Requirement of Navigation			1	L			1
2	NV-2	Glossary of Terms			2	L			2
3	NV-3	Maps					1	L	1
4	NV-4	Map Reading					1	L,P	1
		Total			3		2		5

8. METEOROLOGY (MET)

Ser No	Code	Subject	1st yr	Type	2nd yr	Type	3rd yr	Type	Total periods
1	MT-1	Important of Met in Aviation			1	L			1
2	MT-2	Atmosphere					1	L	1
3	MT-3	Clouds and Precipitation					1	L	1
4	MT-4	Visibility					1	L	1
5	MT-5	Humidity and Condensation					1	L	1
		Total			4		4		5

9. AERO ENGINES (AE)

Ser No	Code	Subject	1st yr	Type	2nd yr	Type	3rd yr	Type	Total periods
1	AE-1	Introduction of Aeroengines	1	L					1
2	AE-2	Types of Engines			1	L			1
3	AE-3	Piston Engines			1	L,P			1
4	AE-4	Jet Engines			1	L			1
5	AE-5	Turboprop Engines			1	L			1
6	AE-6	Consolidation					1	L	1
		Total	1		4		1		6

SPECIALISED SYLLABUS – SD**10. AIRFRAMES (AF)**

Ser No	Code	Subject	1st yr	Type	2nd yr	Type	3rd yr	Type	Total periods
1	AF -1	Aircraft Controls	1	L,P					1
2	AF -2	Fuselage			1	L			1
3	AF -3	Main & Tail Plane			1	L			1
4	AF -4	Ailerons, Elevators & Rudder					2	L	2
5	AF -5	Landing Gear	1	L					1
		Total	2		2		2		6
11. INSTRUMENTS (IN)									
Ser No	Code	Subject	1st yr	Type	2nd yr	Type	3rd yr	Type	Total periods
1	IN-1	Basic Flight Instruments	2	L					2
2	IN-2	Introduction of Radar			3	L			3
3	IN-3	Instrument Battery Test (intro to PABT)					2	L	2
		Total	2		3		2		7
12. AIRCRAFT PARTICULARS (AP)									
Ser No	Code	Subject	1st yr	Type	2nd yr	Type	3rd yr	Type	Total periods
1	AP-1	Aircraft Particulars (Type Specific)	2	L					2
		Total	2						2
13. AERO MODELLING (AM)									
Ser No	Code	Subject	1st yr	Type	2nd yr	Type	3rd yr	Type	Total periods
1	AE-1	History of Aero modeling	1	L					1
2	AE-2	Materials used in Aero modeling	1	L					1
3	AE-3	Types of Aero models	1	L					1
4	AE-4	Flying / Building of Aero models	3	D, P	6	D,P	9	D,P	18
		Total	6		6		9		21
Grand Total									
			24		33		33		90

CHAPTER – I
GENERAL SERVICE KNOWLEDGE

GENERAL SERVICE KNOWLEDGE

DEVELOPMENT OF AVIATION

Period	-	GSK-1
Type	-	Lecture
Term	-	Ist year
Revised By	-	

Trg Aids

1. Computer slides, pointer, black board and marker

Time Plan

2.	(a) Introduction	-	05 minutes
	(b) Explanation	-	32 minutes
	(c) Conclusion	-	03 minutes
	Total	-	40 minutes

INTRODUCTION

1. The idea of human flight has engaged the thought of many men since the beginning of history. Tracing the evolution of flight, one gets into a world of myths, religious beliefs and legends, when some of form of flying was visualized in the encounter and affairs of ancient life. There are the Vimanas of flying chariots in Indian mythology, the winged deities from Egypt and Assyria, the magic carpet from Arabia, the winged horse Pegasus and winged cap and heels of Hermes in Roman and Greek mythology. Mythologies aside, the first scientific venture in aviation were the tentative steps made in the fourth century B.C in China that eventually led to invention of the kite by the sixth century B.C, kites had found their way in military applications.

2. In 1890 LILIENTHAL in Germany started riding the air in gliders and it was his example, which fired the imagination of Wright brothers in America and turned their attention to solving the practical problems of aviation .The Balloon was joined by the parachute in 1797 when the French man, GARAERIN made the first human at PARIS. In 1852 the stream driven Airship became feasible, and also the light pressure ship of SANTOS and DUMONT.

3. The power airplane took ten years (1895-1905) to emerge from the Glider, which was perfected by the Wright Brothers. In 1906 Wright Flyer 111 emerged which could be banked, turned, circled and flown with ease and which could comfortably stay in the air for more then half an hour at a time.

AIM

4.. To teach the NCC cadets about the development of aviation.

5. One of the earliest attempt to construct a flying machine was made by Leonardo Da Vinci, the genius of renaissance period, known for his attempt to design a mechanical device using arms and legs which activated flapping wings through system of pulleys and levers. The machine was called Ornithopter which implies **flapping wing**. This was a flapping wing aircraft powered by human body. Leonardo Da Vinci also designed a screw-copter, the first real concept of the modern helicopter, but even he could not achieve much headway.

6. Francesco Delana-Terzi proposed the first serious project for a lighter aircraft in 1670. It was intended that four thin copper spheres from which all the air had extracted, would lift such an aircraft. Arrival of the balloon as a lighter than air vehicle was a landmark of flight. Two brothers Joseph and Etienne Montgolfier made the first managed lighter than air flight in 1782, while watching a fire in his fire place, Joseph had become interested in the force that caused the spark and smoke to rise. He made a small bag out of silk and lit a fire under the opening at the bottom, so causing it to rise. The brothers thought that such burning created a gas which they called Montgolfier Gas in June 1783. The brothers put on their first public demonstration using a paper lined linen bag 30 feet in diameter. The balloon rose to an altitude of 6000 feet and travelled for over a mile before landing.

7. Sir George Cayley, known as the father aerial navigation designed in 1799. The first airplane with wings, fuselage, tail unit and a means of propulsion. In 1804 he flew the first model airplane which had a kite's shaped wing mounted on a pole with a universally jointed tail unit. Five years later he constructed a full sized Glider which was flown successfully, first unmanned and then with a boy just over a few yards. Much experimentation with Gliders kites and various propulsion systems followed in the 19th century until the first successful manned flight by Orville Wright in 17 December 1903. In 1906, a first flight in Europe was made by the Brazilian, Alberto Santos Dumont over the Bagatelle Park in Paris.

8. Invention of the airship was the next major step in man's endeavours. The LA France, built by Renard and Kareves in 1884. The first flight was in September 1928 and this pioneered passenger travel over the Atlantic long before air planes was capable of long range flight. The Zeppelin of Friedrichsafen in southern Germany built a series of air ship between 1900 and 1936.

9. At the beginning when Orville Wright first experienced a drift in body velocity and felt the defiance of gravity during his flight on 17 December 1903 at Kitty Hawk North Carolina. He was not merely proving yet another of man scientific endeavors into the

unknown. His brother Willbur and he had in fact achieved man's aeons old yearning to fly like a bird and defy the laws of gravity and air current elements of nature believed not to be under his control till then. Three flights on covering over a half a mile the Wright flyer had achieved the first over flight by heavier than aircraft in the recorded history. Men's urge to fly goes back to his earliest observation of birds. The effortless act of flying accomplished by the species drew him to the dynamics of gravity and the air.

10. The first Indian aviator both pilot and aircraft constructor was Prof Venketa Subba Setty of Mysore who was a remarkable person, being the first Indian to fly, and as a pioneer in aeronautical engineer, to design, build and fly an aircraft. This was on 16 June 1912, while he was with A.V Roe and CO (Avro) at Brooklands in the Manchester area of England. VS Setty had joined A.V Roe on 08 May 1911 as a time keeper and within some weeks on 27 May 1911 along with another Indian SV Sippe began to practice for flight in a Gnome powered Farman pusher biplane. Within some months he had rolled (flown) in a 35 H.P Viale engined Avro type D (No.6). On 27 September 1911 Setty had his first flying incident ending up in the sewage farm adjacent to Brooklands which happened frequently to early aviators and Setty ended up there again on 21 February 1912 while flying on Avro type B; but was uninjured. Prof Setty's interests included automobiles, he participated in car races in the U.K and first Indian on a motor cycle born in 1879, this pioneer of aviation only lived till the age of 39, passing away in 1918. There was barely any aviation activity in India during years of the Great War. However a central flying school had been set up in Sitapur on 1 October 1915 under the control of Army HQ with the object of Officers gaining experience under Indian conditions, with some five air planes in service. Individual Indian aviator had, however engaged themselves in aviation pursuits when they managed to enlist in the Royal Flying Course. Lt Hardeep Singh Malik, Lt Indra Lal Roy, D.F.C and Lt SG Welingkar, M.C, where amongst the Indian in the RFC. Although the First World War had disrupted the development of aviation in India, it had given an opportunity for these young pilots to distinguish themselves. Lt Indra Lal Roy was one of the first Indian to receive the king's commission at the age of 18. He was with No.56 Squadron RFC on the western front and No 40 Squadron during July 1918 shooting down several German fighters. Sardar Hardeep Singh Malik who was later to be Indian Ambassador to Paris served in both the RFC and RAF. He had joined the RFC in April 1917, later was in operation with No.28 Squadron and flew Sopwith Camels as a fighter pilot. In 1913 there was about five air machines in India. There was no pilot apart from a few British Officers of the Indian Army who had learned to fly in England in 1915. At the end of the First World War Royal Air Force as the largest bomber in the world.

11. Civil aviation in India picked up soon when intercontinental flights started between Europe and India. As part of British Empire the initiative for development of the aviation, civil and military in India was naturally the prerogative of the British

government. One of Britain's immediate objectives was to have independent air route to India. With Seften Brancker being director of civil aviation during this period, India naturally became the focus point in British aviation plans. Seften Brancker's ambitious plans for intercontinental air links were realized when, on 17 March 1925, he flew aboard a D.H 50 from Croydon terminal in London to Rangoon in Burma and returned back, thereby completing an 8000 miles air trip to India and back. This adventures expedition laid the foundation for intercontinental civil air services. However the first proving flight of KLM Royal Dutch Air lines to Java, past through India even before Brancker took off from London. The KLM flight landed in Karachi on 9 November 1924. The directorate of civil aviation was established in 1927 as an integral part of the department of industries and labour, Lt Col Shelmderdine being appointed as the first director of civil aviation. His first priority was the creation of chain of aerodromes with good permanent hangars incorporating workshops and offices on the Karachi-Calcutta and Karachi-Southern India routes. Another vital task to be accomplished was establishing a wireless communication network and direction finding station, comprising point to point communication on the entire route. Shelmderdine spent considerable time in organizing the state owned India state air services to operate the Indian sector of the entire route between London and Far East. He was also the person pushing for establishing flying clubs across the country as also the aero club of India.

12. Among the early aviators of India, there was an elite class of incredibly talented flying enthusiastic who contributed majorly to the growth and sustenance of aviation in India. There were A.M Engineer, popularly known as ASPY, Man Mohan Singh and JRD Tata. Born on 15 December 1912, A.M Engineer was, at 17 the youngest Indian pilot of the time. He won the Aga Khan Trophy being the first Indian to fly solo from England to India in a Gypsy Moth. Later, he trained at RAF Cranwell where he was adjudged the best all-round cadet was commissioned in to A Flight of IAF, and flew the Wapitis in the North Western frontier province. No 1 Squadron was formed in July 1938, Engineer was appointed the Flight Commander and flew operations in North Waziristan in May 1939. A flight under Engineer's command carried out 403 hours of flying operation, a feat which was acknowledged as remarkable in view of the small number of aircraft and crew available.

13. Another distinguished aviator who became a legend in Indian aviation history was Man Mohan Singh a remarkable person. An engineer from Bristol University, he was the first Indian to fly solo from England to India. He had earlier completed a two years course in flying and aeronautical engineering at Bristol on an Indian government scholarship. In 1934-35 Man Mohan Singh accomplished another solo flight in a light aircraft, again the first by an Indian, from England to South Africa.

14. J.R.D Tata, was the first Indian to secure an A-license within the shortest number of the hours and is perhaps the most acclaimed personality of Indian aviation, the

visionary who laid the foundation for commercial air transport in India. The passion for flying was kindled in him from the legendary Bleriot, the first man to fly across the English Channel. J.R.D's first flight during his childhood days was with a joy-riding pilot in Hardelot. The first entry in his flight logbook was on 22 January 1929 when he made his first flight in a Gypsy Moth at the Bombay flying Club, done remarkable after only 12 days 3 hours and 45 minutes of dual flying experience at the flying club. He lost his air lines service on 15 October 1932 with a Push Moth airmail service to Karachi in 1938 at the age of 34. The pioneering efforts by the house of Tata's ably assisted and nourished by Neville Vintcent, a former RAF pilot who came to India in 1929 and built up the aviation department of Tata Sons as a full fledged domestic air line service which was, two turbulent decades later to evolve into the country's international career, Air India International in 1948.

Lay out of chronological development

Year	Event
1799-1809	George Cayley laid the foundation for the field of Ariel Navigation, Balloons were tried
1890-	Lilienthal discovered gliders
1895-1905	Wright flier 111 was developed
1910	Roe's bi- plane appeared
1919	Rolls –Royce engine was developed
1928	Hele-Shaw –Beachan propeller was designed
1941	Whittle W-1 Turbo Jet was developed
1942	Germans V-2 Rocket engine
1947	Bristol centaurs engine was designed
1954	Rolls- Royce Vertical test rig was developed

Conclusion

15. We have seen here the chronological development of aviation from beginning to era where man flies with the help of machines.

Period	-	GSK-2
Type	-	Lesson
Term	-	1st year
Revised	-	

TRG AIDS

Computer slides, pointer, black board and marker

TIME PLAN

(a)	Introduction	- 05minutes
(b)	Birth, Growth & expansion of IAF	- 20minutes
(c)	The Indian Air Force Today	- 10minutes
(d)	Conclusion	- 05minutes
	Total	- 40 Minutes

INTRODUCTION

1. The Indian Air Force is the youngest the three services even though young. It has a bright history. The bravery, valour and achievement of the officers and airmen of the IAF and integral part of its proud heritage.

AIM

2. To teach the NCC cadets about the history of Indian Air Force.

PREVIEW

3. The class will be conducted in following parts.
 (a) Part I - Birth, Growth and Expansion of IAF
 (b) Part II - The Indian Air Force today

BIRTH OF IAF

4. The origin of the IAF can be traced to the Indian Sandhurst committee known as a Skeeny committee. This committee was setup by the Govt. of India in 1925 with Sir Andrew Skeen, The Chief Of General Staff as its chairman to enquire and recommend the rate at which Indians should be recruited for the grant of commissions in the Armed

forces. The report was published on 1st April 1927. The Skeny committee recommended that steps should be taken to create an Air Arm of the Indian Army and till such time facilities for flying training made available in India, its officers should be trained at Royal Air Force(RAF) college, Cranwell. From 1928 onwards 2 seats were reserved at the RAF college, Cranwell for Indians in 1930, six Indians, selected by the government of India enter the college. They were S.C. Sarkar, Subroto Mukharjee, Bhupinder Singh, Awan, Amarjit Singh and J.N.Tandon.

5. The first batch was granted their as a pilots with the exception of Tandon. He was commissioned in the equipment branch and he became the first equipment officer in Indian Air Force.

6. 22 Airmen were selected on 19 Jan 1932 as a ground staff. They begin their training at Karachi. They were known as hawai sepoys.

7 The Government passed the IAF bill on 4 April 1932. The Indian Air Force came into being with the promulgation of the IAF bill on 8 Oct 1932. The governor general-in-council at that time consequently ordered the establishment of Indian Air Force with effect from 8 Oct 1932. The Indian Air force anniversary is celebrated on 8 Oct every year.

8. No.1 Squadron(A Flight) of the IAF was formed at Drigh Road, Karachi. It consists of 4 Wapiti aircraft, 6 Officers and 22 airmen then known as hawai sepoys. The six officers included the two ex-chiefs of the Air Force, Air Marshal S mukharjee and Air Marshal AM Engineer.

9.. Two more flights (B&C) were formed and added to No.1 squadron in 1936 and 1939 respectively. Flight lieutenant S Mukharjee took over the command of No.1 squadron.

10. When World War II broke out in 1939 the problem of guarding India's vast coastline across and the IAF took active steps to solve it. Training of volunteer reserves.

11. Began in November, 1939. Six coastal defense flights (CDF) were formed at Madras, Bombay, Calcutta, Cochin, Karachi and Vishakapatnam with Wapiti and Atlanta aircraft. Towards the end of 1942, these flights were disbanded and the new squadrons were formed.

GROWTH AND EXPANSION

12. In its early years expansion of IAF was rather slow. In Sep, 1939 it consisted of only one squadron with a complement of 16 officers and 144 airmen. During World War II the increasing commitments of the RAF in Europe and the impact of Japanese invasion in south-east Asia accelerated the pace of progress.

13. At the end of March 1941, No.1 Squadron and 3 CDFs gave up their Wapitis which were requisitioned to equip No.2 Squadron raised at Peshawar in the following

months and were issued instead with Armstrong Withworth Atlanta transport, used to patrol the Sunderbans Delta area south of Calcutta. No.2 CDF had meanwhile received requisitioned D.H.89 Dragon Rapides for convoy and coastal patrol, while No.5 CDF took on strength a single D.H.86 which it used for convoy and patrol the waters of Cape Comorin and the Malabar Coast. By Oct 1943, the strength rose to 8 full squadrons with 911 officers and 40146 airmen. By the end of war two more squadrons were added to it. The squadrons were equipped with variety of aircrafts, viz., Lysander, Wapiti, Audax, Hurricane, Vengeance and Spitfire.

THE INDIAN AIR FORCE TODAY

14. There are five operational Air commands, The Western Air Command with headquarters in Delhi being the prime such and responsible for Air operations from Kashmir southwards to Rajasthan and including the capital and the Punjab, with an operational group dedicated for Jammu and Kashmir including Laddakh. Central Air Command based at Allahabad, encompasses most of Indo-Gangetic plain while, Eastern Air Command, from Shillong, is responsible for Bengal, Assam, the Eastern states of Arunachal Pradesh, Meghalaya, Mizoram and the other bordering on Tibet, Bangladesh and Burma.

15. South Western Air Command, at Gandhinagar, is responsible for air operations in most of Rajasthan, southwards through Gujarat to Saurashtra and the Kutch area. Southern air command was formed in July 1984 with headquarters at Thiruvananthapuram and has, geographically, the largest territory, from the Deccan plateau area to the southern tip of the peninsula and including the islands territories of Lakshadweep and the Andaman and Nicobar islands.

16. Training command has its headquarters at Bangalore with the majority of flying and ground training establishment located in southern India. Maintenance command functioning in out of Nagpur in central India.

17. The five operational commands through administrative wings control some 45 fixed wings squadrons, 20 helicopter units and numerous surface to air missile squadrons, with unit establishments varying from 12 to 18 aircrafts. This represents total aircrafts strength of 1700 including training and support types, manned by some 170000 personnel.

CONCLUSION

18. From the raising of Air Force, It has seen various changes and is marching towards the modernization. Since it is the youngest force it has the responsibility of defending the Air territory of our Country.

19. It is the eye in the sky and has the nature of devastating the enemy of the country. From the organization of the Air force and having a few personnel now it has more than lakh personnel.

20. The five operational commands through administrative wings, control some 45 fix wings squadrons, 20 helicopter units and numerous surface to air missile squadrons, with unit establishments varying from 12 to 18 aircrafts. This represents a total aircrafts strength of 1700 including training and support types, manned by some 170000 personnel.

ORGANISATION OF IAF
(GSK-3)

Period	-	GSK-3
Type	-	Lecture
Term	-	Ist Year
Revised By	-	

Trg Aids

1. Computer slides, pointer, black board and marker

Time Plan

2.	(a) Introduction	-	05minutes
	(b) Explanation	-	30minutes
	(d) Conclusion	-	05minutes
	Total	-	40 Minutes

INTRODUCTION

The President is the Supreme Commander of the Armed Forces of Indian Republic. The primary role of the Air Force is the air defence of the country, means Guarding of our air space from enemy intrusion and giving support to the Army and the Navy. Its secondary role is to aid the civil power in maintaining law and order and in providing relief during natural calamities.

AIM

To teach the NCC cadets about the organization of IAF

EXPLANATION

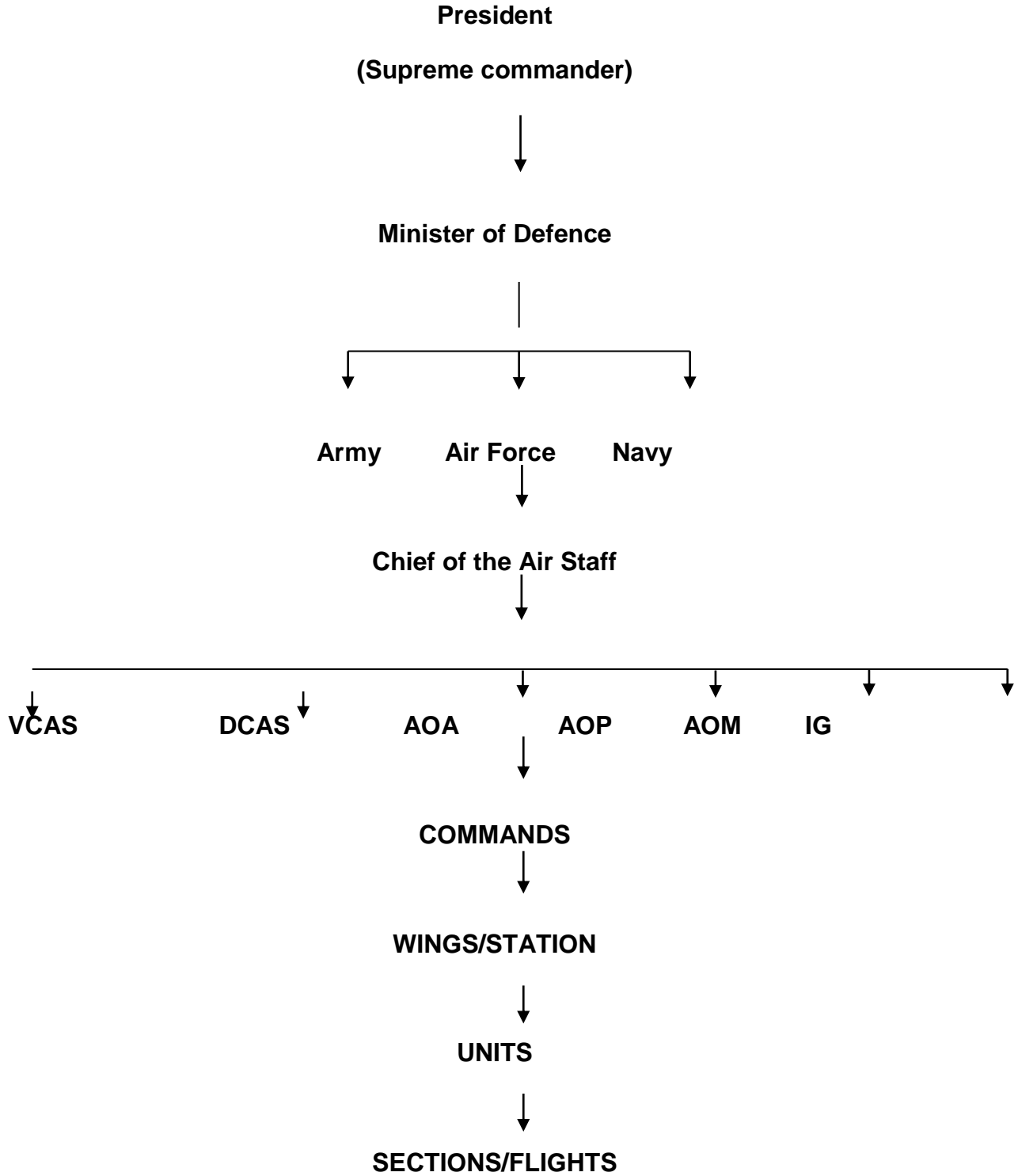

ORGANIZATION CHART OF A WING/STATION

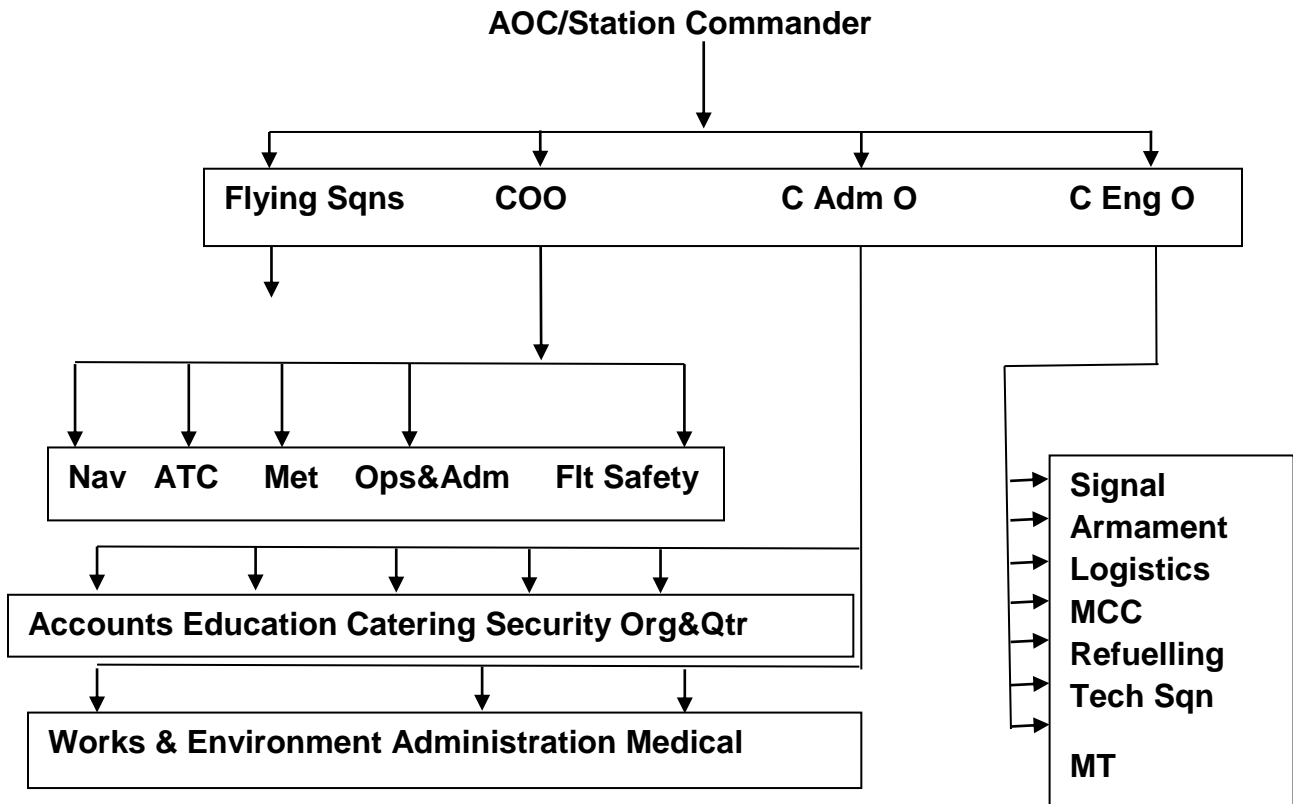

STATION/WING

Station/Wing is always what is called a self accounting unit, i.e it is fully capable and independently responsible for its own administration. A Sqn/lodger units is essentially a non-self accounting unit and it is a lodger to a Wing/Station and depends fully on that Wing/Station for its administration. A Wing/Station exercises its functional and administrative control over its lodger units.

ORGANISATION CHART – OPERATIONAL COMMAND

Air Officer Commanding in Chief

(AOC-in-C)

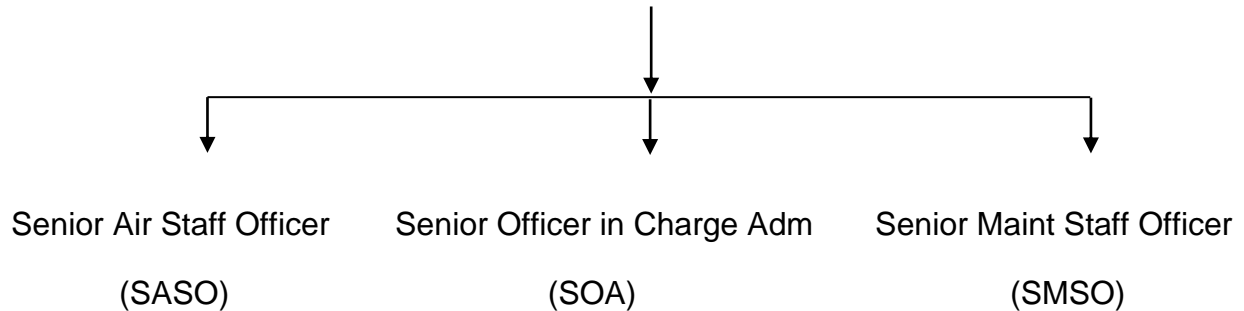

Commands

The Western, Central, Eastern, South Western, Southern Air Commands control all operational units. Operational Commands execute the operational roles of the Air Force in war. They also handle the training of paratroopers for airborne operations. Training Command is responsible for training of Officers and Airman in all flying and ground training at various academy/training institutions/colleges under it. Maintenance Command is responsible for the maintenance, repair and storage of aircraft, MT, Signal equipment, Armament, Ammunition and explosives etc, and exercise functional and administrative control over Base Repair Depot (BRDs) and Equipment Depot (EDs).

Following are the Air Commands with their Head Quarters:-

Southern Air Command	---	Trivandrum
Training Command	---	Bangalore
Eastern Air Command	---	Shillong
Maintenance Command	---	Nagpur
Western Air Command	---	New Delhi
South West Air Command	---	Gandhi Nagar
Central Air Command	---	Allahabad

BRANCHES OF IAF**(GSK-4)**

Period	-	GSK-4
Type	-	Lecture
Term	-	Ist Year
Revised By	-	

Trg Aids

Computer slides, pointer, black board and marker

Time Plan

(a) Introduction	-	05minutes
(b) Explanation	-	30minutes
(d) Conclusion	-	05minutes
Total	-	40 Minutes

INTRODUCTION

3. For smooth functioning of an organization different branches among staff is essential. Vast organization like Indian Air Force requires various branches to make the organization successful and flawless. The responsibility of branches like flying, Medical, Administration and so on has got their respective role. In this lesson we will discuss about branches in IAF.

AIM

4. To teach the NCC cadets about the Branches in IAF

EXPLANATION

Following are the different Branches in the IAF

- (a) Flying Branch
- (b) Navigation Branch
- (c) Education Branch
- (d) Medical Branch
- (e) Administration Branch
- (f) Logistic Branch
- (g) Meteorology Branch
- (h) Engineering Branch

CONCLUSION

5. In this lesson we learnt about various branches of IAF. The branches among personnel made the organization to function smoothly. The role and responsibilities of the branches in IAF perform their activities selflessly and obediently. Without the co-operation there is no existence of an important defence organization like IAF.

MODES OF ENTRY IN THE IAF**(GSK-5)**

Period	-	GSK-5
Type	-	Lecture
Term	-	Ist Year
Revised By	-	

Trg Aids

Computer slides, pointer, black board and chalk

Time Plan

(a) Introduction	-	05minutes
(b) Different types of Entry	-	30minutes
(d) Conclusion	-	05minutes
Total	-	40 Minutes

AIM

To learn about the Modes of Entry in the IAF & Qualification required to enter in the IAF.

EXPLANATION

3. Followings are the essential requirements for entry in the IAF to become Commissioned Officer

Branch/Type of Entry	Educational Qualification	Age Limit	Advertisement Schedule
(A) FLYING BRANCH			
1.National Defence Academy (NDA) For Men only	10+2 With Physics& Math	16 1/2 –19	Mar/Oct
2. Combined Defence Service (CDSE) For	Any Grad. With Physics & Math at	19-23	Apr/Sep

Men only	10+2 or BE		
3. NCC Special Entry (Through COMMANDING OFFICER unit /DG NCC) For Men only	Any Grad. with Physics & Math at 10+2 or BE&NCC Air Wing Sr Div. "C" Certificate	19-23	Jun/Dec
4. Short Service Commission (For Women only)	Any Grad. With Physics Maths at10+2 or BE	19-23	Mar/Sep
(B) TECHNICAL BRANCH (PC For Men/ SCC For Women)			
1. Aeronautical Engineering (Electronics) 2. Aeronautical Engineering (Mechanical)	First class degree in Engineering or GATE score of 70% & above in Electronics / Mechanical/ Allied subjects as per advertisement	18-28	Feb/Aug
(C) GROUND DUTY BRANCH (PC For Men / SCC For Women)			
1. Administration 2. Logistics 3. Accounts	First Class Graduate or PG in subjects as per advertisement	20-23 20-25	Mar/Sep
4. Education 5. Meteorology	PG in subjects as per advertisement	20-25	Mar/Sep

TO BECOME AN AIRMEN

<u>GROUP</u>	<u>*AGE</u> (As on date of Enrolment)	<u>EDUCATIONAL QUALIFICATION</u>
Group 'X' (Technical) Trades	17 - 22 Years	Passed Intermediate / 10+2 / equivalent examination with Mathematics, Physics and English with a minimum of 50% marks in aggregate. OR Three years Diploma course in Engineering (Mechanical / Electrical / Electronics / Automobile / Computer Science / Instrumentation Technology / Information Technology) with at least 50% marks in overall aggregate from a Government recognised Polytechnic Institute.
Group 'X' (Education Instructor) Trade	20-25 Years	Graduate in Arts, Commerce or Science with B. Ed degree/two years teaching experience in a Government recognised School/College. Candidate should have scored a minimum of 50% marks in aggregate in Graduation as well as B. Ed.
	20-28 Years	Passed MA English / M Sc in Mathematics, Physics, Computer Science / MCA with B Ed degree /2 Years teaching experience in a Government recognised School / College.
Group 'Y' Trades (Except Med Asst and Musician Trade)	17-22 Years	Passed Intermediate /10+2 / equivalent examination with Science, Arts or Commerce subjects or equivalent vocational course with minimum 50% marks in aggregate. Vocational courses should be recognised by Association of Indian Universities. OR Three years Diploma in any stream of Engineering from a Government recognised Polytechnic Institute.
Group 'Y' (Med Asst) Trade	17-22 Years	Passed 10+2 / Intermediate / equivalent exam with Physics, Chemistry, Biology and English with a minimum of 50% marks in aggregate.
Group 'Y' (Musician) Trade	17-25 Years	Passed Matriculation /10th class or equivalent with minimum pass marks from any Government recognised School/Boards and should be proficient in playing at least one of the following musical instrument: Trumpet / Bass / Violin / Saxophone / Clarinet / Euphonium / Jazz-Drum / Piccolo / Bass Trombone / Key Board / Guitar / Sarod / Viola / Cello / Contra Bass (String Bass).

Age Date on enrolment

CONCLUSION

During the lecture different types of entry have been discussed for entry in the IAF which including the qualifications and advertisement schedule. For more details log on to www.careerairforce.nic.in

CAREER IN THE IAF AS AN OFFICER/AIRMAN

(GSK-6)

Period	-	GSK-6
Type	-	Lecture
Term	-	III Year
Revised By	-	

Trg Aids

Computer slides, pointer, black board and chalk

Time Plan

(a) Introduction	-	05minutes
(b) Career in the IAF as an Officer/Airman	-	30minutes
(d) Conclusion	-	05minutes
Total	-	40 Minutes

AIM

To learn about the Career in the IAF as an Officer/Airman .

EXPLANATION

3. Followings are the essential requirements for entry in the IAF to become Commissioned Officer

CAREER AS AN AIR FORCE OFFICER

4. An officer is a member of an armed force or uniformed service who holds a position of authority. To be able to lead and control, requires the ability to motivate yourself, inspire others and make tough decisions efficiently. Lessons in team work, developing communication skills and confidence, honing strategic and dynamic thinking are drilled into an Officer during his training. The Air Force teaches all, not only making men and women of young boys and girls but making them leaders in life. An officer's strength of character and strong moral compass make him/her stand out from the crowd at all times.

5. As an Officer in the Indian Air Force, you will inherit a glorious heritage and timeless traditions of the IAF, blended perfectly with the latest technology.

6. As an officer in the Indian Air Force you will strategise, lead and manage. Depending on your qualifications, you could join one of the various branches in the IAF. Broadly the Air Force has three branches with further sub-streams :

(a) **Flying Branch**

- Fighters
- Transports
- Helicopters

(b) **Technical Branch**

- Mechanical
- Electronics

(c) **Ground Duty Branch**

- Administration
- Accounts
- Logistics
- Education
- Meteorology

General Eligibility Criteria for Ground Duty Branches

- **Age** - 20 to 23 Years for Graduates and 20 to 25 years for Post Graduates (at the time of commencement of course). Upper age limit relaxed upto 26 years for Law Graduates (3 Years Course), upto 27 years for CA / ICWA / M Ed / Ph D.
- **Marital Status** - Candidates below the age of 25 years must be Unmarried.
- **Nationality** - Indian
- **Gender** - Both men and women.

CAREER AS AN AIRMAN

7. The initial period of engagement in the IAF is 20 years, which can be extended up to the age of 57 years. Promotion prospects up to the rank of Master Warrant Officer exist to the deserving airmen. Opportunities to become a Commissioned Officer also exist for those airmen who qualify the prescribed examination, later in their service career.

(a) **Service Entry Commission.** Airmen of the rank of Sergeant & above with 10 years of minimum service and within the age limit of 34 to 42 years get the opportunity to become a Commissioned Officer in the IAF.

(b) **Honorary Commission** Selected MWOs/WOs are granted Honorary

Commission in the last year of their service before superannuating on Republic Day and Independence Day each year. On grant of Honorary Commission, they are eligible for higher scales of pay and allowances.

JOB CONTENTS: TRADE WISE

8. On the basis of the performance in the Joint Basic Phase Training (JBPT) at Basic Training Institute, Belgaum specific trades are allotted to the successful candidates. Basic combatant training is imparted to all the recruits, which includes basic discipline and manners, educational training, weapon training etc. After successful completion of basic training, you will be trained in specific trades. PT, Parade and games are integral part of the training and service life. Succeeding paragraphs give an idea of the nature of job an airman is expected to perform in different trades. However, depending on service requirement, an airman may be assigned other jobs as required by his superior authorities and exigencies of service.

GROUP 'X' (TECHNICAL) TRADES

GROUP 'X' (TECHNICAL) TRADES

9 In this trade you are responsible for maintenance and repair of all types of light and heavy duty mechanical vehicles, cranes and loading equipment etc.

- a) Electronics Fitter
- b) Electrical Fitter
- c) Mechanical System Fitter
- d) Structures Fitter
- e) Propulsion Fitter
- f) Workshop Fitter (Smith)
- g) Workshop Fitter (Mechanical)
- h) Weapon Fitter

GROUP 'X' (NON-TECHNICAL) TRADES

- (a) Education Instructor

GROUP 'Y' (NON-TECHNICAL) TRADES

- a) Adm Assistant
- b) Accts Assistant
- c) Medical Assistant
- d) Logistics Assistant
- e) Environment Support Services Assistant (ESSA)
- f) Ops Assistant

- g) Meteorological Assistant
- h) Ground Training Instructor
- i) Indian Air Force (Police)
- j) Indian Air Force (Security)
- k) Musician

GROUP 'Y' (TECHNICAL) TRADES

- a. Communication Technician
- (b) Automobile Technician

CONCLUSION

During the lecture different types of entry have been discussed for entry in the IAF which including the qualifications and advertisement schedule. For more details log on to www.careerairforce.nic.in

CHAPTER – II
AIR CAMPAIGNS

INDO PAK WAR- 1971**(AC-1)**

Period	-	AC-1
Type	-	Lecture
Term	-	1st year
Revised by	-	

Trg Aids

1. Computer slides, pointer, white board and marker pen.

Time Plan

2.	(a)	Introduction	-	05 mins
	(b)	Aggression by Pakistan	-	05 mins
	(c)	Aggression Anticipated	-	05 mins
	(d)	Damage Reported	-	05 mins
		(i) Civil Areas		
		(ii) Military airfields and aircraft		
	(e)	Pakistani Soldiers Surrender	-	02 mins
	(f)	Emergency Declaration	-	03 mins
	(g)	Why Indo Pak War?	-	05 mins
	(h)	Recognition of Bangladesh by India	-	05 mins
	(j)	Summary	-	05 mins
		Total	-	40 Mins

INTRODUCTION

1. India's commitment to peace has always been total and irrevocable. This does not, however, mean submission before force or violence. Gandhiji always made the subtle but significant distinction between non violence and cowardice. Hence, when the Pakistan hordes descended on us on the evening of 3rd December, we were left with no option but to give a fitting reply. This is what precisely our defence forces did. In the process the enemy's war machinery was dealt crippling blows. What is more, our armed forces in conjunction with the Mukti Bahini ended the dark night of oppression and brutality in East Bengal and ushered in the new state of Bangladesh. All this was achieved in a remarkably short period of fourteen days. In fact the unconditional surrender by the enemy's one lakh armed forces is unprecedented.

AGGRESSION BY PAKISTAN

2. Darkness had just fallen on the evening of 3rd December 1971 when air raid alert was sounded at 6 PM in most of the cities in India. With the sounding of siren all lights went off. Everyone including the President, the Cabinet Ministers, the Member of Parliament, the newsmen was taken unaware. The briefing officer told newsmen that the raid alert was a genuine one. Soon people realised the seriousness of the situation. The street lights were never switched ON. The cities were plunged into darkness. The A.I.R then revealed the unfortunate incident of unprovoked aggression by Pakistan.

3. The military junta of Pakistan seem to have chosen the hour of attack with some deliberation and care. The Prime Minister Smt Indira Gandhi was away from New Delhi on days visit to Calcutta, where she had just finished speaking to a large gathering on the Pakistani threat to India's security and the liberation struggle in the Bangladesh. The Defence Minister, Shri Jagjivan Ram was at Patna. The Finance Minister YE Chavan left the capital minutes before the Pakistani attack was launched.

4. The Pakistani Air Force and ground troops following the Israeli type pre-emptive strike had launched a massive attack on the Western front stretching from Jammu & Kashmir to Rajasthan. Pakistani Radio went on the air alleging an Indian attack, when the Pakistani planes were bombing our air fields in sneak raids. Pakistan's friend, philosopher and guide **Peking's New** China News Agency also broadcasted similar allegations.

5. In addition to air raids by the Pakistani Air Force the ground forces also launched a massive attack on our border posts.

AGGRESSION ANTICIPATED

6. Although unprovoked aggression came as a surprise to the people in general, and they were taken unaware, the Govt of India is reported to have anticipated it. The aircraft had been removed from those airfields well in advance. In view of, while damage had been caused to runways or otherwise to some airports, Pakistan's basic strategy failed. The intruding Pakistani fighter planes, despite the persisted raids made on various airfields, could not destroy any Indian aircraft. Necessary steps had been taken by Govt to ensure the safety of our aircraft. Indian anti aircraft guns went into action and IAF Gnats chased the Pakistani planes away. In this process three Pakistani planes had been shot down.

DAMAGE REPORTED

7. **Civil Areas:**

- (a) In Rajasthan six people were injured, when a Pakistani aircraft dropped two bombs near bus stand.
- (b) In Pathankot one person was killed in the Pakistani bombing.
- (c) Houses in Gandhinagar were rocked by the unprovoked Pakistani shelling.

8. **Military airfields and aircrafts**

- (a) Aircraft and one 3 tonne vehicle had been hit by Pakistani bombs near Amritsar. In Halwara Pakistani planes dropped four time bombs which exploded after the aircraft fled.

PAKISTANI SOLDIERS SURRENDER

9. In Akhaura area 12 soldiers of the Pakistani army and 10 personnel from among Pakistani para military troops surrendered to the Indian army.

EMERGENCY DECLARATION

10. It was felt that a state of emergency be declared in the country in order to combat the aggression. The decision was subsequently endorsed by the full cabinet and within five hours of the Pakistani attack, President VV Giri proclaimed a national emergency at 11 PM under article 353 of the constitution.

WHY INDO-PAK WAR?

11 The main problem was creation of conditions in Bangladesh which would be conducive to the safe and speedy return of 11 million refugees which had crossed our borders from East Bengal. During 1972, the cost of feeding refugees would amount to £290 million as against the international aid of about £190 million. On 5th December 1971, Sunday Times, London reported “one result of India’s victory would be the collapse of military rule and the triumph of democracy. It is no paradox therefore, to see that India is fighting to bring freedom to all the people of the sub-continent, who are in the eye of God, one people”.

RECOGNITION OF BANGLA DESH BY INDIA

12. The East Pakistan Rifles and East Bengal Regiment became the Mukti Fouj and later the Mukti Bahini which was joined by thousands of young East Bengal’s determined to sacrifice their lives for freedom. Government of Bengla Desh and Government of India unanimously decided to grant recognition to the ‘Gana Prajatantra Bangladesh’. The father of the new state became Sheikh Mujibur Rehman, Dhaka became the capital.

SUMMARY

13 In fact the suppression by military junta of Pakistan carried on in Bangladesh and the exemplary courage displayed by the people of Bangladesh in facing such situation is not a secret. It has been recorded in the world press. No one can say that India’s decision to recognise Bangladesh is based on emotions and not based on present and future realities. It can also not be said to be a hasty step for recognition was accorded only after Pakistan was unable to exercise any control over the people of Bangladesh. “The will of the nation substantially expressed”. The act of according of recognition to Bangladesh is to admit realities, and since history has such precedence, when an emerging colony was accorded independence, recognition Bangladesh, which has been treated as a colony and which was emerged successfully from its parent country, cannot be condemned by any nation. Later on National flag and National song sung by free country Bangladesh ‘Amar Sonar Banglatomai ami bhalobasi’.

OPERATION SAFED SAGAR**(AC-2)**

Period	-	AC -2
Type	-	Lecture
Term	-	IIInd year
Revised By	-	

Trg Aids

1. Computer slides, pointer, black board and marker

Time Plan

2.	(a) Introduction	-	05 minutes
	(b) Operation Details	-	30 minutes
	(d) Conclusion	-	05 minutes
	Total	-	40 minutes

INTRODUCTION

1. Operation Safed Sagar was the codename assigned to the Indian Air Force's strike to support the Ground troops during Operation Vijay that was aimed to flush out Regular and Irregular troops of the Pakistani Army from vacated Indian Positions in the Kargil sector along the Line of Control. It was the first large scale use of air power in the Jammu and Kashmir region since the Indo-Pakistani War of 1971.

AIM

2. To teach the NCC cadets about the how our country has protected our sovereignty and use military power against infiltration using Air Power.

Ground operations

3. Initial infiltrations were noticed in Kargil in early May, 1999. Because of the extreme winter weather in Kashmir, it was common practice for the Indian and Pakistan Army to abandon forward posts and reoccupy them in the spring. That particular spring, the Pakistan Army reoccupied the forward posts before the scheduled time not only theirs but also which belonged to India, in a bid to capture Kashmir.

4. By the second week of May, an ambush on an Indian army patrol acting on a tip-off by a local shepherd in the Batalik sector led to the exposure of the infiltration. Initially with little knowledge of the nature or extent of the encroachment, the Indian troops in the area initially claimed that they would evict them within a few days. However, soon reports of infiltration elsewhere along the LoC made it clear that the entire plan of attack was on a much bigger scale. India responded with Operation Vijay, a mobilization of 200,000 Indian troops. However, because of the nature of the terrain, division and corps operations could not be mounted; the scale of most fighting was at the regimental or battalion level. In effect, two divisions of the Indian Army numbering 20,000, along with several thousand from the Paramilitary forces of India and the air force were deployed in the conflict zone. The Indian Army moved into the region in full force. Soon, the intruders were found to be well entrenched and while artillery attacks had produced results in certain areas, more remote ones needed the help of the air force.

Air operations

5. The Indian Air Force (IAF) was first approached to provide air support on 11 May with the use of helicopters. On 21 May a Canberra on a reconnaissance mission was hit by ground fire. The flight was however, recovered safely, and returned to base on one engine. On 25 May, the Cabinet Committee on Security authorized the IAF to mount attacks on the infiltrators without crossing the LoC. Initial indications from the government to the IAF was to operate only Attack helicopters. However, the Chief of Air Staff put forth the argument that in order to create a suitable environment for the helicopters, fighter action was required. On 26 May, the go-ahead was given and the IAF started its strike role. Flying from the Indian airfields of Srinagar, Avantipur and Adampur, ground attack aircraft MiG-21s, MiG-23s, MiG-27s, Jaguars and the Mirage 2000 struck insurgent positions.

6. The first strikes were launched on the 26 May, when the Indian Air Force struck infiltrator positions with fighter aircraft and helicopter gunships. The initial strikes saw MiG-27s carrying out offensive sorties, with MiG-21s and (later) MiG-29s providing fighter cover. Mil Mi-17 gunships were also deployed in the Tololing sector. Srinagar Airport was at this time closed to civilian air-traffic and dedicated to the Indian Air Force.

7. However, on 27 May, the first fatalities were suffered when a MiG-21 and a MiG-27 jets were shot down over Batalik Sector by Pakistan Army. The following day, a Mi-17 was lost- with the loss of all four of the crew- when it was hit by three Stinger missiles while on an offensive sortie. These losses forced the Indian Air Force to reassess its strategy. The helicopters were immediately withdrawn from offensive roles as a measure against the man-portable missiles in possession of the infiltrators.

8. On 30 May, the Indian Air Force called into operation the Mirage 2000 which was deemed the best aircraft capable of optimum performance under the conditions of high-altitude seen in the zone of conflict. Armed initially with 250 kg "dumb" bombs, No.7 Squadron over three days, struck infiltrator positions in Muntho Dhalo, Tiger Hill and Point 4388 in the Drass Sector. The strikes on Muntho Dhalo on 17 June also destroyed

logistics and re-supply capabilities of the infiltrators in the Batalik Sector. Through the last weeks of June, the Mirages, armed with LGBs as well as with "dumbs", repeatedly struck the heavily defended Tiger Hill.

9. The choppers used were Mi-8 and the Mi-17. The transport planes were Avro, An-32 and IL-76. On May 27, the IAF had sent a MiG-27 on a photo reconnaissance mission over the Indian side of the Line of Control in Kashmir Pilot ejected from MiG-27 after an engine flameout due to Pakistani retaliation.

10. The next day the Air Force lost an Mi-17 Helicopter to a shoulder fired missile near Tololing, killing the crew of four. This resulted in a change in strategy and technology. With the Israelis providing around 100 Laser-guided bomb kits to the Indian Military, the air force chose to make maximum use of this and retaliated with regular sorties on Pakistani occupied bunkers. The aircraft operated at 10,000 meters AGL (33,000 feet above sea level), well out of MANPADs range, leading to a drop in the accuracy rate of the bombs. The low number of airstrips for take off and landing of the flights also constrained the efficiency of the attacks. Despite this, there were hundreds of sorties on the intruders with no further material or personnel casualties enabling a gradual takeover of the mountain posts by Indian troops. According to IAF the "air strikes against the Pakistani infiltrators, supply camps and other targets yielded rich dividends."

11. By July all the remaining intruders had withdrawn and the operation was ended, being declared a success by the IAF in having achieved its primary objectives. However there has also been criticism of the methods initially used and the type of planes being unsuitable to the terrain that resulted in early losses. This is believed by many in the air force as coming as a wakeup call to upgrade the aging fleet of craft (especially the attack aircraft and helicopters) to better enable them to fight in the mountainous region. But, in the context of the war and in light of the poor information available on the infiltrations, the Indian Air Force was able to coordinate well with the Army and provide air support to the recapture of most the posts before Pakistan decided to withdraw its remaining troops.

CONCLUSION

12. Operation Safed Sagar, as the air operation in the Kargil area was called, was indeed a milestone in the history of military aviation. This was the first time that air power was employed in such an environment. Fighters as well as armed helicopters carried out many hundreds of sorties against the armed intruders who had infiltrated into the Indian Territory. The use of air power in this theatre was instrumental in accelerating the end of the conflict to India's advantage. IAF's air strikes against enemy supply camps and other targets yielded rich dividends. A noteworthy fact is that there was not a single operation on ground that was not preceded by air strikes, each and every action was a result of coordinated planning. The enemy was kept off the backs of the Indian Army. In the area of interdiction of enemy supplies, the successful and incessant attacks on the enemy's logistic machines, over the weeks, culminated in a serious degradation of the enemy's ability to sustain them.

FAMOUS AIR HEROES

(AC-3)

Period	-	AC-3
Type	-	Lecture
Term	-	IIIrd year
Revised By	-	

Trg Aids

1. Computer slides

Time Plan

2.	(a) Introduction	-	02minutes
	(b) Heroes of Air Force	-	35minutes
	(d) Conclusion	-	03minutes
	Total	-	40 minutes

INTRODUCTION

1. The only member of Indian Air Force to be honoured as Marshal of Indian Air Force and Wing Commander Rakesh Sharma, the first Indian to fly into space.

AIM

2. To teach the NCC cadets about the real heroes and role model of IAF

ARJAN SINGH

3. Marshal of the Indian Air Force **Arjan Singh**, DFC was born on 15 April 1919. He is the only officer of the Indian Air Force to be promoted to five-star rank, equal to a Field Marshal, to which he was promoted in 2002. He was born in the Punjab town of Lyallpur, British India, into a Aulakh family. With the death of Field Marshal Sam Manekshaw in June 2008, he is presently the only living Indian military officer with a five-star rank.

Early life and career

4. Arjan Singh was born on 15 April 1919 in Lyallpur in the Punjab in what was then British India. He was educated at Montgomery, India (now in Pakistan). He entered the RAF College Cranwell in 1938 and was commissioned as a Pilot Officer in December 1939. As a distinguished graduate of the RAF College, Singh's portrait is now to be found on the walls of the College's west staircase.

5. Field Marshal Arjan Singh led No. 1 Squadron, Indian Air Force into command during the Arakan Campaign in 1944. He was awarded the Distinguished Flying Cross (DFC) in 1944, and commanded the Indian Air Force Exhibition Flight in 1945.

Career and commands held

6. He was Chief of the Air Staff (CAS), from 1 August 1964 to 15 July 1969, and was awarded the Padma Vibhushan in 1965. He also became the first Air Chief Marshal of the Indian Air Force when, in recognition of the Air Force contribution in the 1965 war, the rank of the Chief of Air Staff was upgraded to that of Air Chief Marshal. After he retired in 1969 at the age of 50, he was appointed the Indian Ambassador to Switzerland in 1971. He concurrently served as the Ambassador to the Vatican. He was appointed High Commissioner to Kenya in 1974. He was member of the Minorities Commission, Government of India from 1975-1981. He was Lt. Governor of Delhi from Dec 1989 - Dec 1990 and was made Marshal of the Air Force in January, 2002.

Career highlights

- 1938-Entered RAF College Cranwell as a Flight Cadet
- 1939-Commissioned in Royal Air Force as a Pilot Officer
- 1940-Flying Officer
- 1942-Flight Lieutenant
- 1944-Squadron Leader
- 1945-Awarded Distinguished Flying Cross
- 1947-Wing Commander, Royal Indian Air Force, Air Force Station, Ambala
- 1948-Group Captain, Director, Training, Air Headquarters
- 1949-Air Commodore, Indian Air Force AOC, Operational Command
- 1961-Air Vice Marshal, Air Officer in Charge, Administration, Air HQ
- 1963-Deputy Chief of Air Staff and subsequently Vice Chief of Air Staff
- 1964-Chief of Air Staff (Air Marshal)
- 1965-Chief of Air Staff rank upgraded to that of an Air Chief Marshal
- 1965-Awarded Padma Vibhushan
- 1966-Chairman of the Chief of Staff Committee
- 1969-Retired from Indian Air Force
- 1971-Ambassador to Switzerland and the Holy See
- 1974-High Commissioner to Kenya
- 1980-Member of the Minorities Commission
- 1989-Lt. Governor, Delhi
- 2002-Marshal of the Air Force

RAKESH SHARMA

7. **Wing Commander Rakesh Sharma**, AC, Hero of the Soviet Union, was born on January 13, 1949 is a former Indian Air Force test pilot who flew aboard Soyuz T-11 as part of the Intercosmos program. Sharma was the first Indian to travel in space.

Early life

8. The first Indian to fly into space, Rakesh Sharma was born on January 13, 1949 in Patiala, Punjab to Hindu Gaur parents, Sharma joined the Indian Air Force in 1970 as a pilot officer after joining the NDA as an IAF cadet in 1966. In the 1971 War, Sharma flew missions in MiG aircraft with considerable success. He was a squadron leader with the Indian Air Force, when he flew into space in 1984 as part of a joint programme between the Indian Space Research Organisation (ISRO) and the Soviet Intercosmos space program. He spent eight days in space on board the Salyut 7 space station. He joined two other Soviet cosmonauts aboard the Soyuz T-11 spacecraft which blasted off on April 2, 1984.

Spaceflight

9. Rakesh Sharma joined the Indian Air Force and progressed rapidly through the ranks. Sharma, then a Squadron Leader and pilot with the Indian Air Force embarked on a historic mission in 1984 as part of a joint space program between the Indian Space Research Organisation and the Soviet Intercosmos space program, and spent eight days in space aboard the Salyut 7 space station. Launched along with two Soviet cosmonauts aboard Soyuz T-11 on the 3 April 1984, Sharma was 35-year-old. Rakesh along with the Soviet Cosmonauts spend 7 days, 21 hours and 40 minutes (Appx. Eight days) in space and board the Salyut 7 space station, a low earth orbit space station, conducting an earth observation programme concentrating on India. He also did life sciences and materials processing experiments, including silicon fusing tests. He is also reported to have experimented with practicing Yoga to deal with the effects of prolonged orbital spaceflight.

10. While Rakesh was in space, he was asked by the then Prime Minister Indira Gandhi on a famous conversation, who asked him how does India look from space, Rakesh replied "Saare Jahan se Achcha Hindustan Hamara" meaning 'Our land of Hindustan, is the Best in the world'.

11. He was conferred with the honour of Hero of Soviet Union upon his return from space. The Government of India conferred its highest gallantry award (during peace time), the Ashoka Chakra on him and the other two Soviet members of his mission. He retired with the rank of Wing Commander. He joined the Hindustan Aeronautics Limited in 1987 and served as Chief Test Pilot in the HAL Nashik Division until 1992, before moving on to Bangalore to work as the Chief Test Pilot of HAL. He retired from test flying in 2001.

CONCLUSION

12. Time to time different heroes sacrifices for our country, for the smooth governing of the citizen. Marshal of Air Force Arjan Singh's contribution during 1965 Indo-China war was recognized by the nation. Wing Commander Rakesh Sharma was the first Indian to travel in space and brought laurel to our country.

MOTIVATIONAL MOVIES**(AC-4)**

Period - AC-4
Type - Movie
Term - Illrd year
Revised By -

Trg Aids

1. Computer , Projector and speakers

Time Plan

2. (a) Introduction - 05 minutes
(b) Branches of IAF - 05 minutes
(c) Join IAF - 25 minutes
(d) Conclusion - 05 minutes

CHAPTER – III
AIRCRAFT RECOGNITION

AIRCRAFT RECOGNITION: FIGHTERS**(ACR-1)**

Period - ACR-1
 Type - Lecture
 Term - IInd year
 Revised By -

Trg Aids

1. Computer slides, pointer, black board and marker.

Time Plan

2.	(a) Introduction	-	05minutes
	(b) Identification	-	05minutes
	(c) Salient features	-	25minutes
	(d) Conclusion	-	05minutes
.	Total	-	40 Minutes

INTRODUCTION

1. Aircraft Recognition is essential to identify the aircraft during both in peace and war.

. IDENTIFICATION OF FIGHTER AIRCRAFTS

1. **DURING PEACE TIME:** Aircraft recognition helps to identify the different types of aircraft possessed by the enemy and assess the strength of the country and prepare for own self defense.

2. **DURING WAR TIME:** Aircraft recognition helps the MOP (mobile observation post) to identify while Aircraft is friend or foe. It also helps to know the capability of the aircraft by identifying its type.

EXPLANATION

There are various methods used to identify the aircrafts:

- | | | |
|---------------------|----------------------------------|------------------------|
| (a) Wing position | (b) Wing shape | (c) Shape of wing tips |
| (d) Shape of canopy | (e) Shape of fins and tail plane | (f) Markings |

(a) Recognition by the wing position:

- | | | |
|-------------------|--------------------|-------------------|
| (i) High wing | (ii) Shoulder wing | (iii) Mid wing |
| (iv) Low mid wing | (v) Low wing | (vi) Parasol wing |

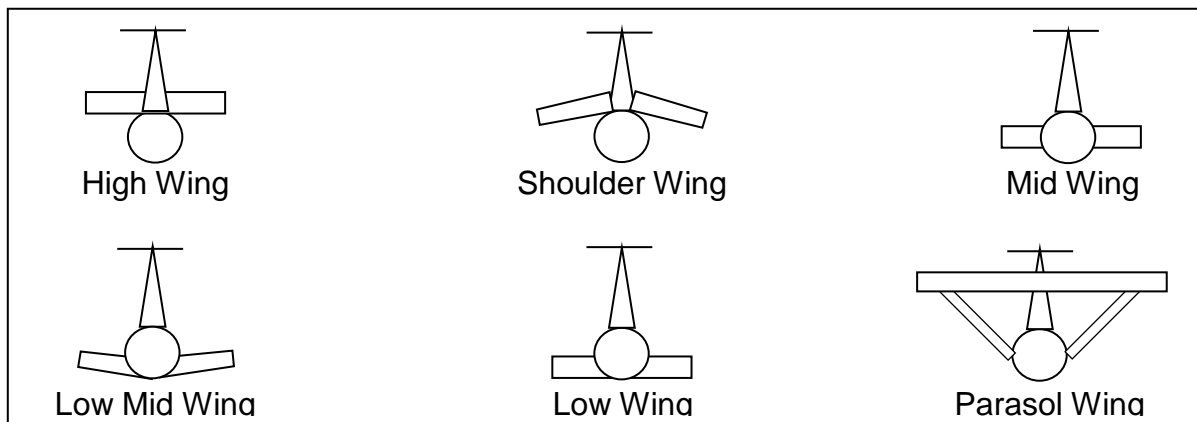

(b) Wing shape:

- | | | |
|---------------------|-------------------|---------------------|
| (i) Rectangular | (ii) Elliptical | (iii) Forward taper |
| (iv) Backward taper | (v) Equitaper | (vi) Delta |
| (vii) Crescent | (viii) Swept back | (ix) Swept forward |
| (x) Bi-plane | (xi) Mono plane | (xii) Dihedral |
| (xiii) Anhedral | | |

(c) Shape of wing tip:

- | | | | |
|--------------|------------|---------------|-------------|
| (i) Circular | (ii) Taper | (iii) Pointed | (iv) Square |
|--------------|------------|---------------|-------------|

(d) Shape of canopy:

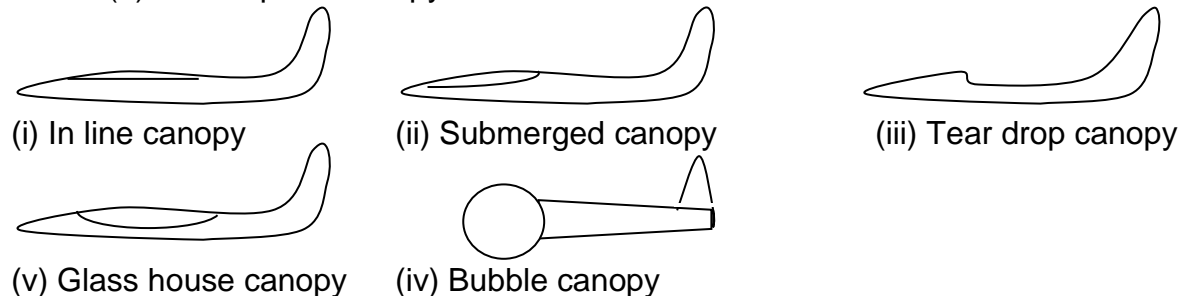

(d) Shape of fin and tail plane:

- | | | |
|-------------------------|--------------------------|----------------------|
| (i) High tail plane | (ii) High mid tail plane | (iii) Mid tail plane |
| (iv) Low mid tail plane | (v) Low tail plane | |

(f) Markings:

(a) Indian Air Force

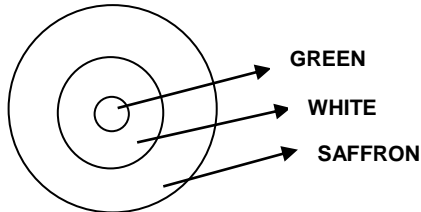

On fuselage & below wing

SAFFRON	WHITE	GREEN
---------	-------	-------

SALIENT FEATURES - FIGHTER AIRCRAFTS

KIRAN (HJT-16)

Role: Basic Jet and Armament Trainer

Particulars:

Length/Span/Height--	10.6 / 10.7 / 2.67 Metres
Max Take-Off Weight--	5000 Kgs
Fuel Capacity--	1345+4X255 Litres (Drop Tanks)
Pay Load--	2X250 Kg Bombs (or Rocket Pods) plus 2X7.62 mm Guns

Performance:

Cruise/Max Speed--	600/715 KMPH
Range--	1075 Km
Engine (Thrust)--	Single Turbojet(1900 Kg)

Special Features

- Indigenous design of HAL.MK-II has high powered engine and four (instead of two) hard points for weapons.
- Still in use with the IAF.

MIG- 21 BIS

Role: Single Seater Air Combat/Ground Attack.

Particulars:

Length/Span/Height--	15.0 / 7.15/ 4.13 Metres
Max Take-Off Weight--	10,470 Kgs
Fuel Capacity--	2,885 + 1,780 Litres(Drop Tanks)
Pay Load--	2,020 Kgs including four close combat missiles plus 23 mm twin barrel gun.

Performance:

Cruise / Max Speed--	1,480/2,175 Kmph
Range--	1900 Km
Engine (Thrust)--	Single Turbojet (7500 Kg)

Special Features

- Five hard-points(Four under wings and one under fuselage)
- 125 aircraft shall undergo up gradation at HAL as a result of Rs.1100 crore agreement with Russian design Bureau ANPK-MIG.

MIRAGE 2000

Role: Single Seater Air Combat.

Particulars:

Length/Span/Height--	14.5 / 9.0/ 3.4 Metres
Max Take-Off Weight--	16,500 Kgs
Fuel Capacity--	3800 + 2 X 1700 Litres(Drop Tanks)
Pay Load--	6000 Kgs(Four missiles + 2 X 20 mm DEFA guns)

Performance:

Max Speed--	Mach 2.35 at 11 Km altitude.
Range--	1480 Km
Engine (Thrust)--	One Turbo-fan (9700 kg)

Special Features

- Nine hard-points for pay load, two under each wing and five under fuselage, a rare feature of any combat aircraft.
- French design, inducted into IAF in 1987.

JAGUAR

Role: Deep penetration strike aircraft.

Particulars:

Length/Span/Height--	16.95 /8.7/ 4.8 Metres
Max Take-Off Weight--	15,700 Kgs
Fuel Capacity--	4200 + 3 X 1200 Litres(Drop Tanks)
Pay Load--	4,750 Kgs(2 X 30 mm ADEN guns)

Performance:

Max Speed--	1350 kmph.
Range--	3500 Km
Engine (Thrust)--	Two Turbojet (3810 kg each)

Special Features

- Seven hard-points, four under each wing, one under fuselage and two over wings(a unique feature).
- UK-France design, built under licence by HAL.

LIGHT COMBAT AIRCRAFT (LCA)

Role: Single Seater Multi Role Combat.

Particulars:

Length/Span/Height--	13.2 / 8.2/ 4.4 Metres
Max Take-Off Weight--	8,500 Kgs
Pay Load--	4000 Kgs(Beyond-Visual-Range missiles, Reconnaissance/Electronic Warfare pods and 23 mm GSH gun.

Performance:

- Single engine aircraft expected to be supersonic at all altitude.
- Small size will reduce its chances of detection by enemy radars.
- Capable of Take-off and landing from very short runways.
- Inertial navigation system for accurate navigation and guidance.
- In flight refuelling probe for extended range.

Special Features

- Once in the air, it shall be world's smallest light weight and highly manoeuvrable combat aircraft with seven hard-points.
- It is being developed by aeronautical development agency with contribution from more than 100 government/private agencies.

CONCLUSION

The individual has to learn to recognize aircraft. In this lesson we have learnt about how to recognize the various fighter aircrafts of IAF. Many factors are involved in making an identification of an aircraft and the distance at which it can be positively identified. Some of these are size, viewing angle, visibility, aircraft finish, visual characteristics, colour and external markings

TRANSPORTS**(ACR-2)**

Period - ACR-2
 Type - Lecture
 Term - IInd year
 Revised By -

Trg Aids

1. Computer slides, pointer, black board and marker

Time Plan

2.	(a) Introduction	-	05minutes
	(b) Identification	-	05minutes
	(c) Salient features	-	25minutes
	(d) Conclusion	-	05minutes
	Total	-	40 Minutes

INTRODUCTION

1. Aircraft Recognition is essential to identify the aircraft during both in peace and war.

Identification of Transport Aircrafts

2. **DURING PEACE TIME:** Aircraft recognition helps to identify the different types of aircraft possessed by the enemy and assess the strength of the country and prepare for own self defense.
3. **DURING WAR TIME:** Aircraft recognition helps the MOP (mobile observation post) to identify while Aircraft is friend or foe. It also helps to know the capability of the aircraft by identifying its type.

EXPLANATION

There are various methods used to identify the aircrafts:

- | | | |
|---------------------|----------------------------------|------------------------|
| (a) Wing position | (b) Wing shape | (c) Shape of wing tips |
| (d) Shape of canopy | (e) Shape of fins and tail plane | (f) Markings |

(a) Recognition by the wing position:

- | | | |
|-------------------|--------------------|-------------------|
| (i) High wing | (ii) Shoulder wing | (iii) Mid wing |
| (iv) Low mid wing | (v) Low wing | (vi) Parasol wing |

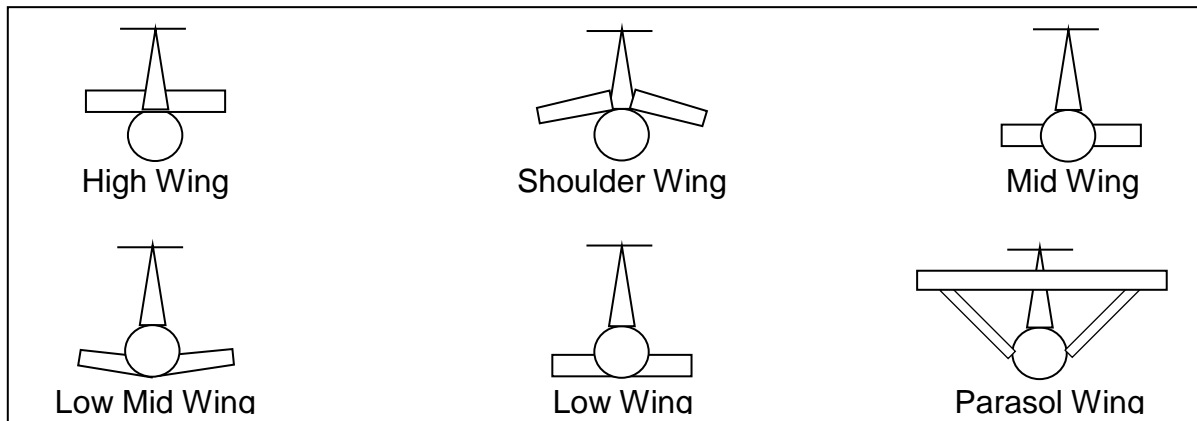

(b) Wing shape:

- | | | |
|---------------------|-------------------|---------------------|
| (i) Rectangular | (ii) Elliptical | (iii) Forward taper |
| (iv) Backward taper | (v) Equitaper | (vi) Delta |
| (vii) Crescent | (viii) Swept back | (ix) Swept forward |
| (x) Bi-plane | (xi) Mono plane | (xii) Dihedral |
| (xiii) Anhedral | | |

(c) Shape of wing tip:

- | | | | |
|--------------|------------|---------------|-------------|
| (i) Circular | (ii) Taper | (iii) Pointed | (iv) Square |
|--------------|------------|---------------|-------------|

(d) Shape of canopy:

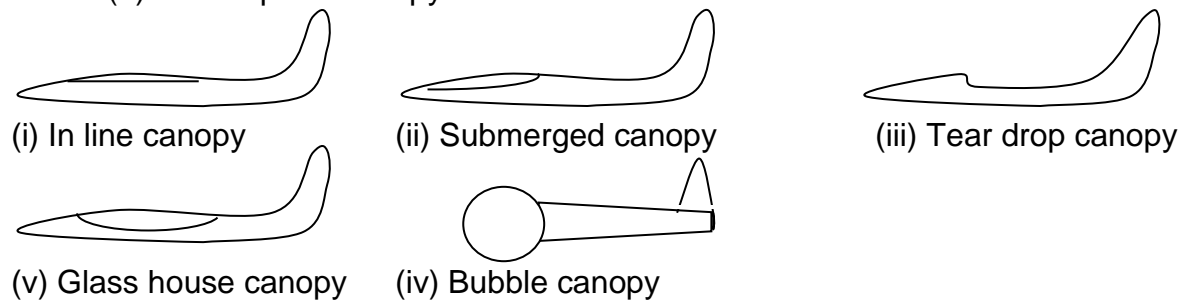

(d) Shape of fin and tail plane:

- | | | |
|-------------------------|--------------------------|----------------------|
| (i) High tail plane | (ii) High mid tail plane | (iii) Mid tail plane |
| (iv) Low mid tail plane | (v) Low tail plane | |

(f) Markings:

(a) Indian Air Force

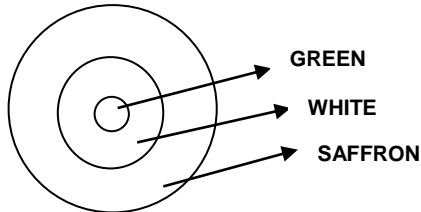

On fuselage & below wing

SAFFRON	WHITE	GREEN
---------	-------	-------

SALIENT FEATURES - TRANSPORT AIRCRAFTS

DORNIER-228

Role: Utility/Commuter Aircraft.

Particulars:

Length/Span/Height--	16.56 / 16.97/ 4.86 Metres
Max Take-Off Weight--	5980 Kgs
Fuel Capacity--	2380 Litres
Pay Load--	1900 Kgs (upto 19 passengers)

Performance:

Cruise/Max Speed--	428 Kmph
Range--	2700 Km
Engine (Power)--	Two Turbo-props (715 HP each)

Special Features

- For maritime role, it is fitted with high-resolution radar with a scanning range of 475 Km with a capacity of track 32 targets.
- Two under-wing pods for carrying guns for spraying oil binding pollutants in pollution-prevention role.

AVRO (HS-748)

Role: Medium Lift Transport.

Particulars:

Length/Span/Height--	20.42 / 30.02/ 7.57 Metres
Max Take-Off Weight--	21000 Kgs
Fuel Capacity--	6550 Litres
Pay Load--	5220 Kgs

Performance:

Cruise Speed--	452 Kmph
Range--	1482 Km
Engine (Power)--	Two Turbo-props (2280 hp each)

Special Features

- British Aerospace Design, first produced by HAL, Kanpur Division under licence in 1964.
- Used by the IAF, BSF and other agencies in a variety of roles like VIP duties, navigator/signaller training and para-dropping.

AN - 32

Role: Short/Medium Lift Transport.

Particulars:

Length/Span/Height--	23.8 / 29.2/ 8.6 Metres
Max Take-Off Weight--	26000 Kgs
Fuel Capacity--	7000 Litres
Pay Load--	6700 Kgs (upto 39 para-troopers)

Performance:

Cruise Speed--	530 Kmph
Range--	2500 Km
Engine (Power)--	Two Turbo-props (5170 hp each)

Special Features

- It is able to operate from high altitude airfields such as Leh.
- Acquired from the then USSR in 1984 in fairly large numbers to replace the old war-horse 'Dakota' aircraft.

IL - 76

Role: Heavy Duty, Long Range Transport.

Particulars:

Length/Span/Height--	46.6 / 50.5/ 14.8 Metres
Max Take-Off Weight--	1,70,000 Kgs
Fuel Capacity--	51,300 Litres
Pay Load--	40,000 Kgs(upto 225 para-troopers)

Performance:

Cruise Speed--	850 Kmph
Range--	6,500 Km
Engine (Power)--	Four Turbo-fans (12000 Kg each)

Special Features

- Three IL-76 can airlift an entire infantry battalion with its equipment and ammunition across the sub-continent in a few hours.

It carries 2 X 23 mm guns in the tail.

EMBRAER(135-BJ)

Role: Passenger version transport aircraft to carry the passengers.

Particulars:

Length/Span--	86.5 /68.92Metres
Fuel Capacity--	8314 Litres

Special Features:

- It can carry 19 passenger.

BOEING-737-200

Role: It is an American Transport aircraft used by the IAC on its internal routes in India to carry the passengers.

Particulars:

Length/Span/Height--	30.48 /28.35/ 11.28 Metres
Fuel Capacity--	26,026Litres
Pay Load--	15544 Kgs

Performance:

Max/Cruise Speed--	940/845 Kmph
Range--	3555 Km
Engine (Power)--	Two Pratt & Whitney Turbo-fans (6575 Kg)

I

Special Features

- It accommodates up to 119 passengers with a crew of two, or carries 15544kg of cargo in all cargo version.

CONCLUSION

The individual has to learn to recognize aircraft. In this lesson we have learnt about how to recognize the various transport aircrafts of IAF. Many factors are involved in making an identification of an aircraft and the distance at which it can be positively identified. Some of these are size, viewing angle, visibility, aircraft finish, visual characteristics, colour and external markings

HELICOPTERS
(ACR-3)

Period - ACR-3
 Type - Lecture
 Term - IInd year
 Revised By -

Trg Aids

1. Computer slides, pointer, black board and marker

Time Plan

2.	(a) Introduction	-	05minutes
	(b) Identification	-	05minutes
	(c) Salient features	-	25minutes
	(d) Conclusion	-	05minutes
	Total	-	40 Minutes

INTRODUCTION

1. Aircraft Recognition is essential to identify the aircraft during both in peace and war.

. Identification of Helicopters

2. **DURING PEACE TIME:** Aircraft recognition helps to identify the different types of aircraft possessed by the enemy and assess the strength of the country and prepare for own self defense.
3. **DURING WAR TIME:** Aircraft recognition helps the MOP (mobile observation post) to identify while Aircraft is friend or foe. It also helps to know the capability of the aircraft by identifying its type.

EXPLANATION

There are various methods used to identify the aircrafts:

- | | | |
|---------------------|----------------------------------|------------------------|
| (a) Wing position | (b) Wing shape | (c) Shape of wing tips |
| (d) Shape of canopy | (e) Shape of fins and tail plane | (f) Markings |

(a) Recognition by the wing position:

- | | | |
|-------------------|--------------------|-------------------|
| (i) High wing | (ii) Shoulder wing | (iii) Mid wing |
| (iv) Low mid wing | (v) Low wing | (vi) Parasol wing |

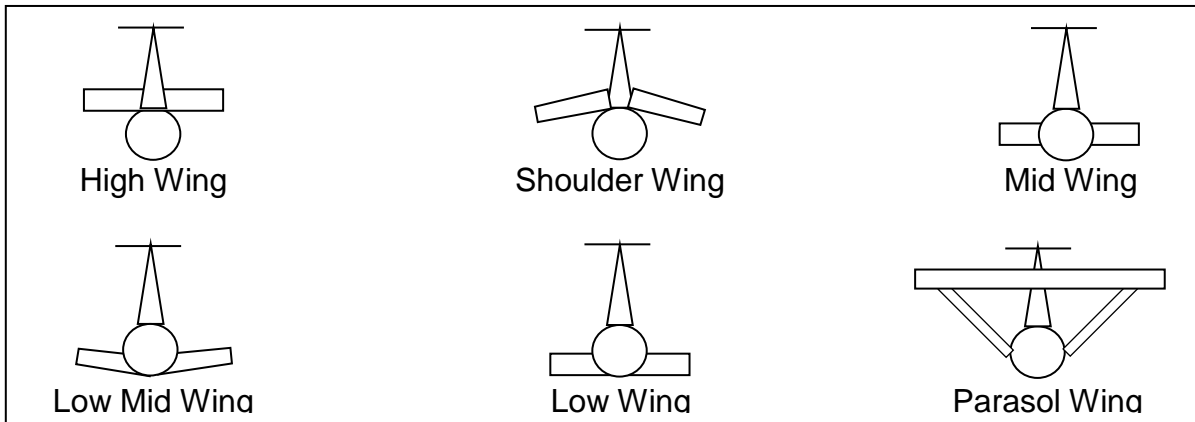

(b) Wing shape:

- | | | |
|---------------------|-------------------|---------------------|
| (i) Rectangular | (ii) Elliptical | (iii) Forward taper |
| (iv) Backward taper | (v) Equitaper | (vi) Delta |
| (vii) Crescent | (viii) Swept back | (ix) Swept forward |
| (x) Bi-plane | (xi) Mono plane | (xii) Dihedral |
| (xiii) Anhedral | | |

(c) Shape of wing tip:

- | | | | |
|--------------|------------|---------------|-------------|
| (i) Circular | (ii) Taper | (iii) Pointed | (iv) Square |
|--------------|------------|---------------|-------------|

(d) Shape of canopy:

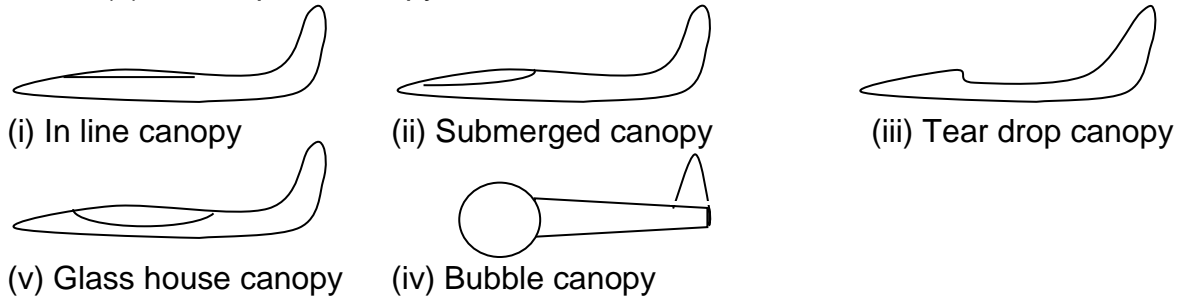

(d) Shape of fin and tail plane:

- | | | |
|-------------------------|--------------------------|----------------------|
| (i) High tail plane | (ii) High mid tail plane | (iii) Mid tail plane |
| (iv) Low mid tail plane | (v) Low tail plane | |

(f) Markings:

(a) Indian Air Force

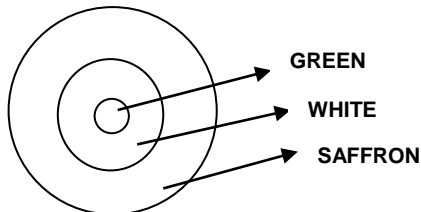

On fuselage & below wing

SAFFRON	WHITE	GREEN
---------	-------	-------

SALIENT FEATURES - HELICOPTERS

Chetak (Alouette-III)

Role: General Purpose Light Transport.

Particulars:

Length/ Height--	10.03 /3.09 Metres
Max Take-Off Weight--	2100 Kgs
Fuel Capacity--	575 Litres
Pay Load--	05 Passengers

Performance:

Cruise/Max Speed--	190/210 KMPH
Range--	500 Km
Engine (Power)--	Single Turbo shaft(586 HP)

Special Features

- French design, built under licence by HAL.
- It's other version, Cheetah is lighter by 150 Kg, thus suitable for operations at high altitudes of Leh, Ladakh and Siachen Glacier.

MI-17

Role: Medium Range Lift Helicopter.

Particulars:

Length/Height--	18.2 / 5.65 Metres
Max Take-Off Weight--	13000 Kgs
Fuel Capacity--	3680 Litres
Pay Load--	3300 Kgs (24 Combat Troops)

Performance:

Cruise/Max Speed--	240/256 KMPH
Range--	950 Km
Engine (Thrust)--	Two Turbo shafts(1900 hp each)

Special Features

- It is an upgraded version of MI-8, with better engine power. It has tail rotor on port side of vertical stabiliser.
- It can carry six pods of 57 mm rockets.

KAMOV (Ka-25)

Role: Anti-Submarine warfare.

Particulars:

Length/Height--	9.75 / 5.37 Metres
Max Take-Off Weight--	7500 Kgs
Pay Load--	Dipping Sonar, Search radar, Air to Surface guided missiles.

Performance:

Cruise/Max Speed--	193/209 KMPH
Range--	400 Km
Engine (Thrust)--	Two Turbo shafts(900 hp each)

Special Features

- It does not have any tail rotor. Instead it has two sets of main rotor blades rotating in opposite direction.
 - Main rotor blades can be folded for ease of storage.

MI-26

Role: Heavy Lift Helicopter.

Particulars:

Length/Height--	33.7 / 8.6 Metres
Max Take-Off Weight--	56000 Kgs
Pay Load--	20000 Kgs (70 Combat Troops)

Performance:

Cruise/Max Speed--	255/295 KMPH
Range--	800 Km
Engine (Thrust)--	Two Turbo shafts(11400 HP each)

Special Features

- Main rotor has eight blades and tail rotor has five blades.
- Normal crew of five consisting of pilot, co-pilot, flight engineer, navigator and load master.

MI-8

Role: Medium Range Lift Helicopter.

Particulars:

Length/Height--	25.24 / 5.65 Metres
Fuel Capacity--	2960 Litres
Pay Load--	24 Combat Troops

Special Features

- It has tail rotor on starboard side of vertical stabiliser.

MI-25

Role: Fighter Helicopter.

Particulars:

Length/Height--	17.50 / 6.5 Metres
Fuel Capacity--	2055 Litres

CONCLUSION

The individual has to learn to recognize aircraft. In this lesson we have learnt about how to recognize various helicopter of IAF. Many factors are involved in making an identification of an aircraft and the distance at which it can be positively identified. Some of these are size, viewing angle, visibility, aircraft finish, visual characteristics, colour and external markings

FOREIGN AIRCRAFT
(ACR-4)

Period - ACR-4
 Type - Lecture
 Term - IInd year
 Revised By -

Trg Aids

1. Computer slides, pointer, black board and marker

Time Plan

2.	(a) Introduction	-	05minutes
	(b) Identification	-	05minutes
	(c) Salient features	-	25minutes
	(d) Conclusion	-	05minutes
	Total	-	40 Minutes

INTRODUCTION

1. Aircraft Recognition is essential to identify the aircraft during both in peace and war.

Identification of Foreign Aircrafts

2. **DURING PEACE TIME:** Aircraft recognition helps to identify the different types of aircraft possessed by the enemy and assess the strength of the country and prepare for own self defense.
3. **DURING WAR TIME:** Aircraft recognition helps the MOP (mobile observation post) to identify while Aircraft is friend or foe. It also helps to know the capability of the aircraft by identifying its type.

EXPLANATION

There are various methods used to identify the aircrafts:

- | | | |
|---------------------|----------------------------------|------------------------|
| (a) Wing position | (b) Wing shape | (c) Shape of wing tips |
| (d) Shape of canopy | (e) Shape of fins and tail plane | (f) Markings |

(a) Recognition by the wing position:

- (i) High wing
- (iv) Low mid wing

- (ii) Shoulder wing
- (v) Low wing

- (iii) Mid wing
- (vi) Parasol wing

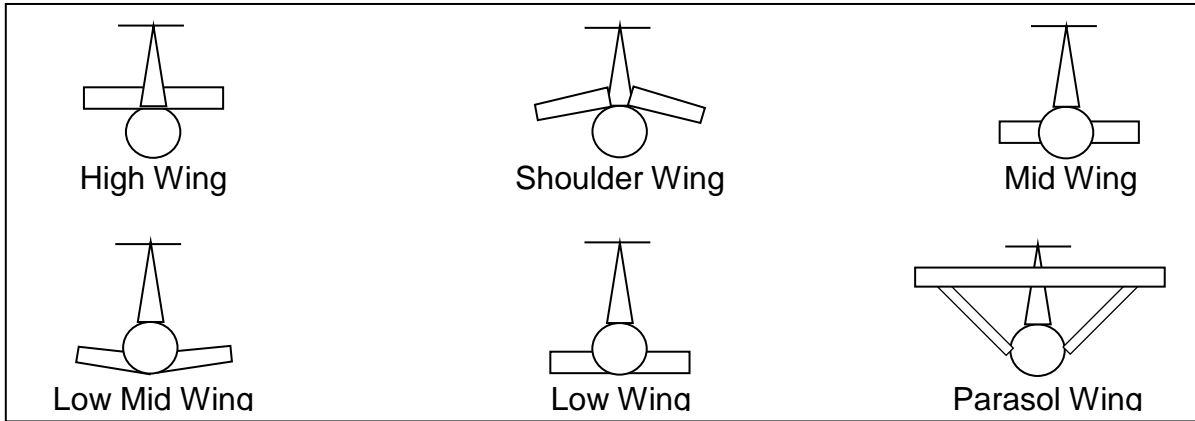

(b) Wing shape:

- (i) Rectangular
- (iv) Backward taper
- (vii) Crescent
- (x) Bi-plane
- (xiii) Anhedral

- (ii) Elliptical
- (v) Equitaper
- (viii) Swept back
- (xi) Mono plane

- (iii) Forward taper
- (vi) Delta
- (ix) Swept forward
- (xii) Dihedral

(c) Shape of wing tip:

- (i) Circular

- (ii) Taper

- (iii) Pointed

- (iv) Square

(d) Shape of canopy:



(i) In line canopy



(ii) Submerged canopy



(iii) Tear drop canopy



(v) Glass house canopy



(iv) Bubble canopy

(d) Shape of fin and tail plane:

- (i) High tail plane
- (iv) Low mid tail plane

- (ii) High mid tail plane
- (v) Low tail plane

- (iii) Mid tail plane

(f) Markings:

(a) Indian Air Force

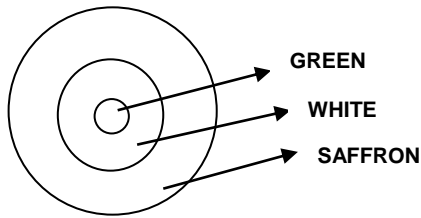

On fuselage & below wing

SAFFRON	WHITE	GREEN
---------	-------	-------

SALIENT FEATURES - FOREIGN AIRCRAFTS

Pakistan MIG- 19

Role: Single Seater all weather day fighter.

Particulars:

Length/Span/Height-- 41'5" / 29'6" / 12'5"
 Pay Load-- Three 30 MM Cannon and two ATOL AAMs or up to four pods, each housing nineteen 55 Mm rockets.

Performance:

Max Speed-- 902 Mph
 Range-- 1365 Miles
 Engine (Thrust)-- Two Klimov VK-9 (7850 lbs each)

Special Features

- Manufactured by Russia and used by Pakistan and Chinese Air Force.

MIRAGE - 5

Role: Single Seater Ground Attack fighter aircraft.

Particulars:

Length/Span/Height-- 15.55 /8.22/ 4.25 Metres
 Max Take-Off Weight-- 4200 Kgs
 Pay Load-- Two 30 mm DEFA 5-52 cannon with 125 rounds per gun and seven external ordnance sdtations.

Performance:

Cruise / Max Speed-- 956/2230 Kmph

Special Features

- Manufactured by France and used by Pakistan Air Force.

C - 130 HERCULES

Role: Heavy duty transport aircraft.

Particulars:

Length/Span/Height-- 97'9" / 132'7" / 38'3"
 Pay Load-- It can carry upto 92 troops, 64 Litters and two attendants, or cargo 45000 lbs.

Performance:

Cruise / Max Speed-- 340/384 Mph
 Range-- 2400 Miles
 Engine (Power)-- Four Allison T 56 Turbo-props engines.

Special Features

- Manufactured by USA and used by Pakistan Air Force.
- The fuselage has a large protruding chin under the cockpit.

SIKORSKY S – 61 (SEA-KING)

Role: Medium Range Lift Helicopter.

Particulars:

Length/Height-- 72'8" 16'10"

Performance:

Cruise/Max Speed-- 136/166 Mph
 Range-- 625 Miles
 Engine (Thrust)-- Two T 58-GE-10 Turbo shafts(1400 hp each)

Special Features

- Manufactured by USA.
- The cabin can accommodate 26 troops, 15 Litters or cargo. It has also a provision for 840 lbs of weapons.

China**MIG- 15**

Role: Single Seater day interceptor fighter aircraft.

Particulars:

Length/Span/Height--	33'1¾" / 33'0¾"/ 12'1¾"
Pay Load--	It carries one 37 MM and two 23 MM canon plus two 550 lbs bombs.

Performance:

Cruise / Max Speed--	480/668 Mph
Engine (Thrust)--	Single Turbojet

Special Features

- This mid wing aircraft has swept back wings with very slight taper ending in tapered wing tips.

CONCLUSION

The individual has to learn to recognize aircraft. In this lesson we have learnt about how to recognize the various aircrafts of neighbouring countries. Many factors are involved in making an identification of an aircraft and the distance at which it can be positively identified. Some of these are size, viewing angle, visibility, aircraft finish, visual characteristics, colour and external markings.

CHAPTER – IV
MODERN TRENDS

MODERN TRENDS
(MT-1)

Period - MT-1
 Type - Lecture
 Term - Illrd year
 Revised By -

Trg Aids

1. Computer slides, pointer, black board and chalk

Time Plan

2.	(a) Introduction	-	05 minutes
	(b) Modern Trends	-	05 minutes
	(c) Equipment or Technology used	-	25 minutes
	(d) Conclusion	-	05 minutes
	Total	-	40 Minutes

INTRODUCTION

1. Use of science and technology in every field always improves the work efficiencies and reduces the work load and increase the production rate and field of aviation is not far behind. Since the mid-1960s, computer technology has been continually developed to the point at which aircraft and engine designs. Ability and efficiency of a human being always limited and varies in conditions. Here we will see how the use of technology changes the capabilities of a pilot either civil or military. This also shows that superiority of machine over human being that a machine can works beyond the limit where a human being can only imagine.

2. Here is the list of modern inventions or equipment that changes the field of aviation. Autopilot, Fly by Wire, UAV, Glass cockpit, GPS, NVG, Composite materials, Stealth Technology

AIM

3. To teach the NCC cadets about the advancement and requirement in aviation and use of new technology and equipment and its limitation.

AUTOPILOT

4. In the early days of aviation, aircraft required the continuous attention of a pilot in order to fly safely. As aircraft range increased allowing flights of many hours, the constant attention led to serious fatigue. An autopilot is designed to perform some of the tasks of the pilot.

5. The first aircraft autopilot was developed by Sperry Corporation in 1912. The autopilot connected a gyroscopic Heading indicator and attitude indicator to hydraulically operated elevators and rudder (ailerons were not connected as wing dihedral was counted upon to produce the necessary roll stability.) It permitted the aircraft to fly straight and level on a compass course without a pilot's attention, greatly reducing the pilot's workload.

6. Further development of the autopilot was performed, such as improved control algorithms and hydraulic servomechanisms. Also, inclusion of additional instrumentation such as the radio-navigation aids made it possible to fly during night and in bad weather. In 1947 a US Air Force C-54 made a transatlantic flight, including takeoff and landing, completely under the control of an autopilot. The installation of autopilots in aircraft with more than twenty seats is generally made mandatory by international aviation regulations. There are three levels of control in autopilots for smaller aircraft. A single-axis autopilot controls an aircraft in the roll axis only; such autopilots are also known colloquially as "wing levelers," reflecting their limitations. A two-axis autopilot controls an aircraft in the pitch axis as well as roll, and may be little more than a "wing leveler" with limited pitch oscillation-correcting ability; or it may receive inputs from on-board radio navigation systems to provide true automatic flight guidance once the aircraft has taken off until shortly before landing; or its capabilities may lie somewhere between these two extremes. A three-axis autopilot adds control in the yaw axis and is not required in many small aircraft. Modern autopilots use computer software to control the aircraft. The software reads the aircraft's current position, and then controls a Flight Control System to guide the aircraft. In such a system, besides classic flight controls, many autopilots incorporate thrust control capabilities that can control throttles to optimize the airspeed, and move fuel to different tanks to balance the aircraft in an optimal attitude in the air. Although autopilots handle new or dangerous situations inflexibly, they generally fly an aircraft with a lower fuel-consumption than a human pilot.

FLY BY WIRE:

7. **Fly-by-wire** (FBW) is a system that replaces the conventional manual flight controls of an aircraft with an electronic interface. The movements of flight controls are converted to electronic signals transmitted by wires (hence the fly-by-wire term), and

flight control computers determine how to move the actuators at each control surface to provide the ordered response. The fly-by-wire system also allows automatic signals sent by the aircraft's computers to perform functions without the pilot's input, as in systems that automatically help stabilize the aircraft.

8. Mechanical and hydro-mechanical flight control systems are relatively heavy and require careful routing of flight control cables through the aircraft by systems of pulleys, cranks, tension cables and hydraulic pipes. Both systems often require redundant backup to deal with failures, which increases weight.

The term "fly-by-wire" implies a purely electrically-signaled control system. It is used in the general sense of computer-configured controls, where a computer system is interposed between the operator and the final control actuators or surfaces. This modifies the manual inputs of the pilot in accordance with control parameters.

FURTHER DEVELOPMENT

Fly-by-optics

9. Fly-by-optics is sometimes used instead of fly-by-wire because it can transfer data at higher speeds the cables are just changed from electrical to fiber cables.

Power-by-wire

10. The power circuits power electrical or self-contained electro hydraulic actuators that are controlled by the digital flight control computers. All benefits of digital fly-by-wire are retained along with elimination of bulky and heavy hydraulic circuits.

Fly-by-wireless

11. Fly-by-wireless systems are very similar to fly-by-wire systems; however, instead of using a wired protocol for the physical layer a wireless protocol is employed.

Limitations

12. If one of the flight-control computers crashes, or is damaged in combat, or suffers from "insanity" caused by electromagnetic pulses, the others overrule the faulty one (or even two of them), they continue flying the aircraft safely, and they can either turn off or re-boot the faulty computers. Any flight-control computer whose results disagree with the others is ruled to be faulty, and it is either ignored or re-booted.

UAV

13. The UAV is an acronym for Unmanned Aerial Vehicle, which is an aircraft with no pilot on board. UAVs can be remote controlled aircraft (e.g. flown by a pilot at a ground control station) or can fly autonomously based on pre-programmed flight plans or more

complex dynamic automation systems. UAVs are currently used for a number of missions, including reconnaissance and attack roles. There are a wide variety of drone shapes, sizes, configurations, and characteristics. They are predominantly deployed for military applications, but also used in a small but growing number of civil applications, such as firefighting and nonmilitary security work, such as surveillance of pipelines. UAVs are often preferred for missions that are too 'dull, dirty, or dangerous' for manned aircraft.

Types:

Target and decoy - providing ground and aerial gunnery a target that simulates an enemy aircraft or missile

Reconnaissance - providing battlefield intelligence.

Combat - providing attack capability for high-risk missions.

Research and development - used to further develop UAV technologies to be integrated into field deployed UAV aircraft.

Civil and Commercial - UAVs specifically designed for civil and commercial applications

Endurance

14. Because UAVs are not burdened with the physiological limitations of human pilots, they can be designed for maximized on-station times. The maximum flight duration of unmanned, aerial vehicles varies widely. Internal-combustion-engine aircraft endurance depends strongly on the percentage of fuel burned as a fraction of total weight and so is largely independent of aircraft size.

Limitations

15. UAV survivability is a double-edged sword. Although the reduced radar cross section, low infrared signature, and reduced noise level are strengths of UAVs as noted earlier, they are not invulnerable and one of the major problems with UAVs is the lack of in flight refueling capability.

Glass cockpit

16. Before 1970's aircraft were not considered sufficiently demanding to require advance equipment like electronics flight displays. Also computer technology was not at a level where sufficient light and powerful circuit were available. The increasing complexity of transport aircraft, the advent of digital systems and growing air traffic congestion around airports began to change that.

17. The average transport aircraft in the mid-1970 had more than one hundred cockpit instrument and controls, and the primary flight instrument were already crowded with indicators , crossbars and symbols and the growing number of cockpit elements were competing for cockpit space and pilot attention. As a result NASA conducted research on displays that could process the raw aircraft system and flight data into an integrated, easily understood picture of the flight situation, culminating in a series of flight demonstrating a full glass cockpit system.

18. A glass cockpit is an aircraft cockpit that features electronics instrument displays rather than mechanical gauge .It is as simple as that. A glass cockpit uses displays driven by flight management system that can be adjusted to displays flight information as needed. This simplifies aircraft operation and navigation and allows pilot to focus only on the most pertinent information. They are also popular with airlines companies as they usually eliminate the need for a flight engineer.

Safety

19. As aircraft operation becomes more dependent on glass cockpit systems, flight crews must be trained to deal with possible failure. In one glass cockpit the Airbus A320, fifty incidents of glass cockpit blackout have occurred .In Jan 2008 US Airline flight 731 experienced a serious glass cockpit blackout, losing half of the displays as well as all radios, transponder, and attitude indicator. Glass cockpit blackouts are the main reasons flight training students need to know how to fly with and without electronics instrument displays.

Conclusion

20. These are the few equipments we discussed here that overcome the stress level of pilot at a certain extent and increase the efficiencies of man and machines upto the next height . We will discuss on some more equipments in next lecture.

CHAPTER – V
PRINCIPLES OF FLIGHT

PRINCIPLE OF FLIGHT
INTRODUCTION (ELEMENTARY MECHANICS)
(PF-1)

Period -- I
Type -- Lecture
Term -- I/I
Revised by --

Trg Aids

1. Computer slides, pointer, black board and chalk.

Time Plan

2.	(a)	Intro	-	05 mins
	(b)	Stalling	-	30 mins
	(c)	Conclusion	-	05 mins
		Total	-	40 Mins

"When once you have tasted flight, you will forever walk the earth with your eyes turned skyward, for there you have been, and there you will always long to return." - Leonardo da Vinci

INTRO

(Slide 01)

1. It is essential to have a basic knowledge of elementary mechanics to understand the various Principles of Flight, because both the aircraft and the atmosphere in which it flies are Matters and all matter are subjected to the laws of mechanics. Terms like Mass, Density, Motion, Speed, Velocity, Acceleration, Newton's First Law of Motion, Momentum, Force, Pressure, Newton's Third Law of Motion, Weight, Work, Power, Energy, Law of Conservation of Energy, Moment of a Force, Couple, and Equilibrium.

AIM

(Slide 02)

4. To teach Flying Cadets about elementary mechanics required to understand aerodynamics.

PREVIEW

(Slide 03)

5. The class will be conducted in the following parts:-
- (a) Mass
 - (b) Density
 - (c) Speed
 - (d) Velocity
 - (e) Acceleration
 - (f) Newton's First Law of Motion
 - (g) Momentum
 - (h) Force
 - (j) Pressure
 - (k) Newton's Second Law of Motion
 - (l) Newton's Third Law of Motion
 - (m) Weight
 - (n) Work
 - (o) Power
 - (p) Energy
 - (m) Law of Conservation of Energy
 - (n) Momentum of a Force
 - (o) Couple
 - (p) Equilibrium
 - (q) Centre of Gravity (CG)
 - (r) Kinetic Energy

PRINCIPLE OF FLIGHT
LAWS OF MOTION (PF-2)

Period	--	I
Type	--	Lecture
Term	--	I/I
Revised by	--	

Trg Aids

3. Computer slides, pointer, black board and chalk.

Time Plan

4.	(a)	Intro	-	05 mins
	(b)	Stalling	-	30 mins
	(c)	Conclusion	-	05 mins
		Total	-	40 Mins

INTRO

(Slide 01)

2. It is essential to have a basic knowledge of elementary mechanics to understand the various Principles of Flight, because both the aircraft and the atmosphere in which it flies are Matters and all matter are subjected to the laws of mechanics. Terms like Mass, Density, Motion, Speed, Velocity, Acceleration, Newton's First Law of Motion, Momentum, Force, Pressure, Newton's Third Law of Motion, Weight, Work, Power, Energy, Law of Conservation of Energy, Moment of a Force, Couple, and Equilibrium.

AIM

(Slide 02)

5. To teach Flying Cadets about elementary mechanics required to understand aerodynamics.

LAWS OF MOTION

(Slide 04)

6. **Mass:** Unit - Kilogram (kg) - 'The quantity of matter in a body.' The mass of a body is a measure of how difficult it is to start or stop, ("a body", in this context, means a substance. Any substance a gas, a liquid or a solid).

7. **Density**: It is the mass per unit volume.
8. **Motion**: Motion is said to be there when a body changes its position in relation to its surroundings.
9. **Speed**: Speed is the rate of change of position.
10. **Velocity**: Velocity is speed in particular direction. Velocity is a vector quantity having both magnitude and direction.
11. **Acceleration**: Acceleration is the rate of change of velocity. The change may be in magnitude or direction or in both. Thus a body moving along a circular path at constant speed has acceleration.

$$\text{Acceleration} = \frac{\text{Force}}{\text{Mass}}$$

12. **Newton's First Law of Motion**: A body will continue to be in state of rest or of uniform motion in a straight line unless acted upon by an external force. This property of all bodies is called inertia and a body in such a state is said to be in Equilibrium.
13. **Momentum**: Unit - Mass x Velocity (kg-m/s) - 'The quantity of motion possessed by a body'. The tendency of a body to continue in motion after being placed in motion.
14. **Force**: Unit - Newton (N) - 'A push or a pull'. That which causes or tends to cause a change in motion of a body.
15. **Pressure**: Pressure is force per unit area.
16. **Newton's Second Law of Motion**: The rate of change of momentum of a body is directly proportional to the applied force and takes place in the direction of the application of the said force.
17. **Newton's Third Law of Motion**: To every action, there is an equal and opposite reaction.
18. **Weight**: (a) The earth exerts a certain force towards its centre on all objects on its surface. This force is called Weight of the body and is equal to the mass of the body multiplied by the acceleration due to gravity 'g'. Unit - Newton (N) - 'The force due to gravity'. ($F = m \times g$)
19. **Work**: Unit - Joule (J) - A force is said to do work on a body when it

moves the body in the direction in which the force is acting. The amount of work done on a body is the product of the force applied to the body and the distance moved by that force in the direction in which it is acting. If a force is exerted and no movement takes place, no work has been done.

e.g. (a) Work = Force x Distance (through which the force is applied)

.20. **Power:** Unit - Watt (W) - Power is simply the rate of doing work, (the time taken to do work)

$$\text{e.g. (a) Power (W) = } \frac{\text{Force (N) x Distance (m)}}{\text{Time (s)}}$$

21. **Energy:** Unit - Joule (J) - Mass has energy if it has the ability to do work. The amount of energy a body possesses is measured by the amount of work it can do. The unit of energy will therefore be the same as those of work, joules.

.22. **Law of Conversation of Energy:** The sum total of all energy in the universe remains constant.

23. **Momentum of a Force:** Moment of a force is the turning effect of the force about a point and is measured as the product of the force and the perpendicular distance between the point and the line of action of the force.

24. **Couple:** A couple consists of two equal and opposite and parallel forces not acting through the same point. The moment of a couple is equal to the force multiplied by the perpendicular distance between the two lines of action.

25. **Equilibrium:** A body is said to be in equilibrium when

- (i) Algebraic sum of all the forces acting on the body is zero.
- (ii) Clockwise moment is equal to the anticlockwise moment about any point.

26. **Centre of Gravity (CG):** The point through which the weight of an aircraft acts.

- (a) An aircraft in flight is said to rotate around its CG.
- (b) The CG of an aircraft must remain within certain forward and aft limits, for reasons of both stability and control

27. **Kinetic Energy:** Unit - Joule (J) - 'The energy possessed by mass because of its motion'. 'A mass that is moving can do work in coming to rest'.

$$\text{KE} = \frac{1}{2} m V^2 \text{ joules}$$

CONCLUSION

28. A flying object is a mechanical body in a three dimensional space. The knowledge of above definitions is necessary for effective understating of Principle of Flight.

PRINCIPLE OF FLIGHT - GLOSSARY OF TERMS
(PF-3)

Period	--	I
Type	--	Lecture
Term	--	I/II
Revised by	--	

Trg Aids

5. Computer slides, pointer, black board and chalk.

Time Plan

6.	(a)	Intro	-	05 mins
	(b)	Stalling	-	30 mins
	(c)	Conclusion	-	05 mins
		Total	-	40 Mins

“Do not let yourself be forced into doing anything before you are ready.”- Wilbur Wright

INTRO

(Slide 01)

3. The following are the Main Glossary of Terms which required for understanding, Principle of Flight. Like Aerofoil, Chord line, Chord length, angle of attack, angle of incidence, total reaction, lift, drag, Thrust and weight.

AIM

(Slide 02)

6. To teach Flying Cadets about different Glossary of Terms used in aerodynamics.

PREVIEW

(Slide 03)

5. The class will be conducted in the following parts:-
- (a) Aerofoil
 - (b) Chord line
 - (c) Chord length
 - (d) Angle of Attack
 - (e) Angle of Incidence
 - (f) Total Reaction
 - (g) Lift
 - (h) Drag
 - (j) Thrust
 - (k) Weight

GLOSSARY OF TERMS

(Slide 04)

6. **Aerofoil:** A body designed to produce more lift than drag. A typical aerofoil section is cambered on top surface and is more or less straight at bottom.
7. **Chord line:** It is a line joining the centres of curvature of leading and trailing edges of an aerofoil section.
8. **Chord length:** It is the length of chord line intercepted between the leading and trailing edges.
9. **Angle of attack:** It is the angle between the chord line and the relative air flow undisturbed by the presence of aerofoil.

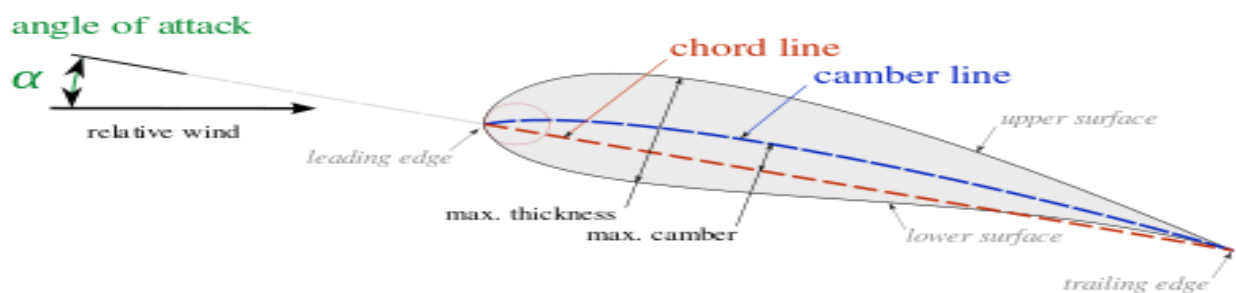

10. **Angle of incidence:** The angle between the chord line and the longitudinal axis of the aircraft.
11. **Total Reaction:** It is one single force representing all the pressures (force per unit area) over the surface of the aerofoil. It acts through the centre of pressure which is situated on the chord line.
12. **Lift:** The vertical component of Total Reaction, resolved at right angles to the relative airflow.
13. **Drag:** The horizontal component of the Total Reaction acting angles and in the same direction as the relative airflow.

CONCLUSION

14. The Flying cadets should have thorough understanding of the above definitions for better understanding of Principle of Flight and aerodynamics of flying objects.

PRINCIPLE OF FLIGHT - BERNOULLI'S PRINCIPLE & VENTURI EFFECT
(PF-4)

Period -- I
 Type -- Lecture
 Term -- II/II
 Revised by --

Trg Aids

7. Computer slides, pointer, black board and chalk.

Time Plan

8.	(a)	Intro	-	05 mins
	(b)	Stalling	-	30 mins
	(c)	Conclusion	-	05 mins
		Total	-	40 Mins

“The exhilaration of flying is too keen, the pleasure too great, for it to be neglected as a sport.”- Orville Wright

INTRO

(Slide 01)

1. The relationship between the velocity and pressure exerted by a moving liquid is described by the **Bernoulli's principle**: as the velocity of a fluid increases, the pressure exerted by that fluid decreases.

2. Airplanes get a part of their lift by taking advantage of Bernoulli's principle. Race cars employ Bernoulli's principle to keep their rear wheels on the ground while traveling at high speeds.

AIM

(Slide 02)

9. To teach Flying Cadets about Bernoulli's Principle and Venturi Effect.

PREVIEW

(Slide 03)

4. The class will be conducted in the following parts:-
- (a) Bernoulli's Principle
 - (b) Venturi Effect

BERNOULLI'S PRINCIPLE

(Slide 04)

5. **Bernoulli's principle** states that for an inviscid flow, an increase in the speed of the fluid occurs simultaneously with a decrease in pressure or a decrease in the fluid's potential energy.

6. **Venturi Effect:** At low flight speeds, air experiences relatively small changes in pressure and negligible changes in density. This airflow is termed incompressible since the air may undergo changes in pressure without apparent changes in density. Such airflow is similar to the flow of water, hydraulic fluid, or any other incompressible fluid. This suggests that between any two points in the tube, the velocity varies inversely with the area. **Venturi effect** is the name used to describe this phenomenon. Fluid flow speeds up through the restricted area of a venturi in direct proportion to the reduction in area. The Figure below suggests what happens to the speed of the flow through the tube discussed.

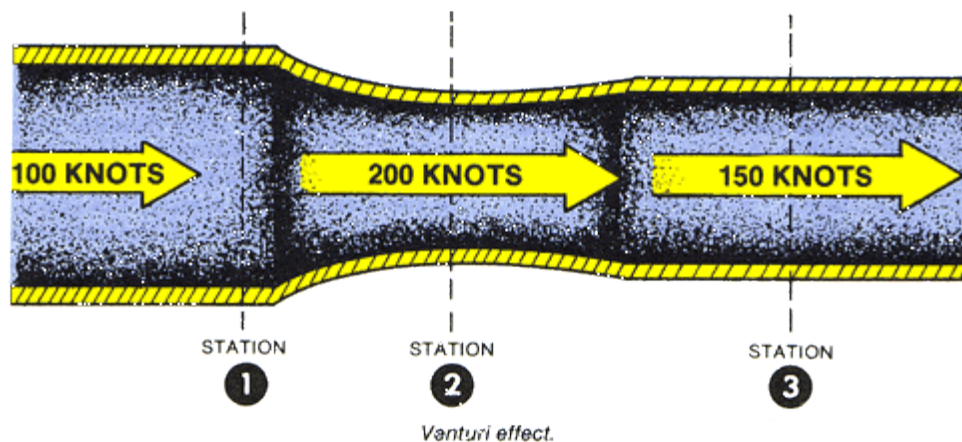

7. The total energy in a given closed system does not change, but the form of the energy may be altered. The pressure of the flowing air may be likened to energy in that the total pressure of flowing air will always remain constant unless energy is added or taken from the flow. In the previous examples there is no addition or subtraction of energy; therefore the total pressure will remain constant.

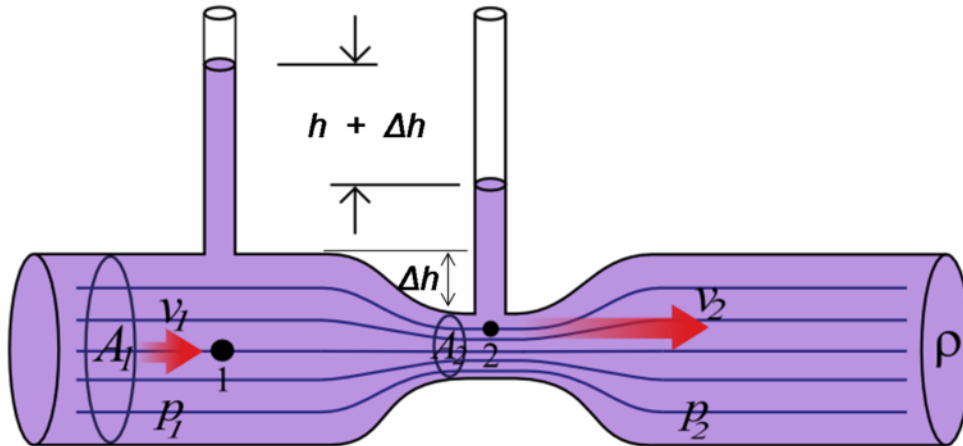

8. Fluid flow pressure is made up of two components - Static pressure and dynamic pressure. The **Static Pressure** is that measured by an aneroid barometer placed in the flow but not moving with the flow. The **Dynamic Pressure** of the flow is that component of total pressure due to motion of the air. It is difficult to measure directly, but a pitot-static tube measure's it indirectly. The sum of these two pressures is *total pressure* and is measured by allowing the flow to impact against an open-end tube which is venter to an aneroid barometer. This is the incompressible or slow-speed form of the Bernoulli equation.

9. Static pressure decreases as the velocity increases. This is what happens to air passing over the curved top of an aircraft's airfoil. Consider only the bottom half of a venturi tube in the Figure below. Notice how the shape of the restricted area at Station 2 resembles the top surface of an airfoil. Even when the top half of the venturi tube is taken away, the air still accelerates over the curved shape of the bottom half. This happens because the air layers restrict the flow just as did the top half of the venturi tube. As a result, acceleration causes decreased static pressure above the curved shape of the tube. A pressure differential force is generated by the local variation of static and dynamic pressures on the curved surface.

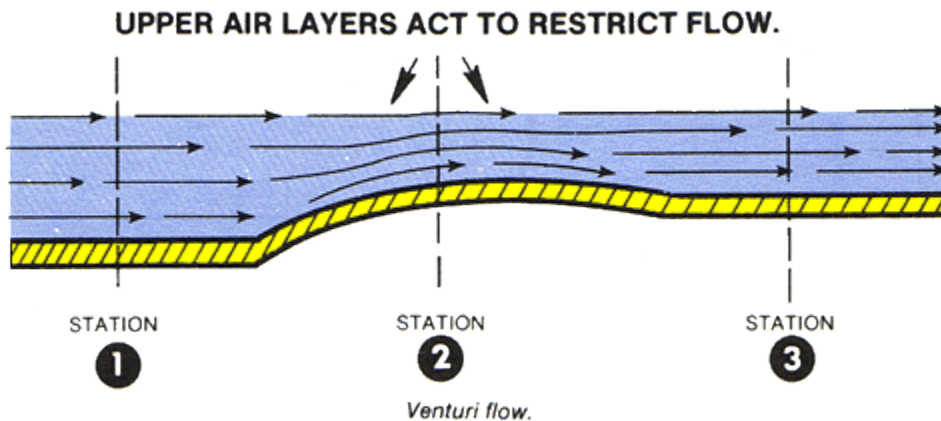

PRINCIPLE OF FLIGHT – AEROFOIL
(PF-5)

Period -- I
 Type -- Lecture
 Term -- III/III
 Revised by --

Trg Aids

10. Computer slides, pointer, black board and chalk.

Time Plan

11.	(a)	Intro	-	05 mins
	(b)	Aerofoil	-	30 mins
	(c)	Conclusion	-	05 mins
		Total	-	40 Mins

“The Wright Brothers created the single greatest cultural force since the invention of writing. The airplane became the first World Wide Web, bringing people, languages, ideas, and values together.” – Bill Gates

INTRO

(Slide 01)

1. Aerofoil is the shape of a wing or blade (of a propeller, rotor or turbine) or sail as seen in cross-section.

An airfoil-shaped body moved through a fluid produces an aerodynamic force. The component of this force perpendicular to the direction of motion is called lift. The component parallel to the direction of motion is called drag. Subsonic flight airfoils have a characteristic shape with a rounded leading edge, followed by a sharp trailing edge, often with asymmetric camber. Foils of similar function designed with water as the working fluid are called hydrofoils.

AIM

(Slide 02)

2. To teach Flying Cadets the definition and types of Aerofoil.

PREVIEW

(Slide 03)

3. The class be conducted in the following parts:-
- (a) Aerofoil
(b) Types of Aerofoil

AEROFOIL

(Slide 04)

4. A fixed-wing aircraft's wings, horizontal, and vertical stabilizers are built with airfoil-shaped cross sections, as are helicopter rotor blades. Airfoils are also found in propellers, fans, compressors and turbines.

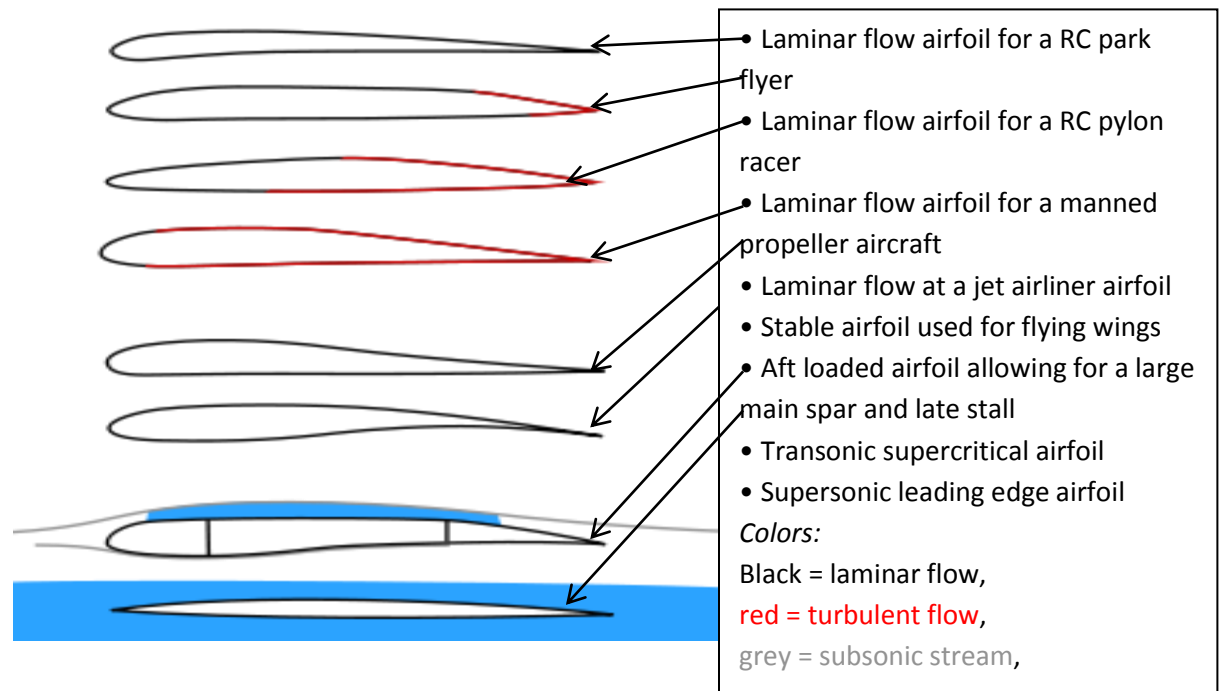

5. Any object with an angle of attack in a moving fluid, such as a flat plate will generate an aerodynamic force (called lift) perpendicular to the flow. Airfoils are more efficient lifting shapes, able to generate more lift (up to a point), and to generate lift with less drag.

6. An airfoil with a positive camber produces lift at zero angle of attack. With increased angle of attack, lift increases in a roughly linear relation, called the *slope* of

the lift curve. At about 18 degrees this airfoil stalls, and lift falls off quickly beyond that. The drop in lift can be explained by the action of the upper-surface boundary layer, which separates and greatly thickens over the upper surface at and past the stall angle. The thickened boundary layer's displacement thickness changes the airfoil's effective shape, in particular it reduces its effective camber, which modifies the overall flow field so as to reduce the circulation and the lift. The thicker boundary layer also causes a large increase in pressure drag, so that the overall drag increases sharply near and past the stall point.

7. Airfoil design is a major facet of aerodynamics. Various airfoils serve different flight regimes. Asymmetric airfoils can generate lift at zero angle of attack, while a symmetric airfoil may better suit frequent inverted flight as in an aerobatic airplane. In the region of the ailerons and near a wingtip a symmetric airfoil can be used to increase the range of angles of attack to avoid spin-stall. Thus a large range of angles can be used without boundary layer separation. Subsonic airfoils have a round leading edge, which is naturally insensitive to the angle of attack. The cross section is not strictly circular, however: the radius of curvature is increased before the wing achieves maximum thickness to minimize the chance of boundary layer separation. This elongates the wing and moves the point of maximum thickness back from the leading edge.

8. Supersonic airfoils are much more angular in shape and can have a very sharp leading edge, which is very sensitive to angle of attack. A supercritical airfoil has its maximum thickness close to the leading edge to have a lot of length to slowly shock the supersonic flow back to subsonic speeds. Generally such transonic airfoils and also the supersonic airfoils have a low camber to reduce drag divergence. Modern aircraft wings may have different airfoil sections along the wing span, each one optimized for the conditions in each section of the wing.

9. Movable high-lift devices, flaps and sometimes slats, are fitted to airfoils on almost every aircraft. A trailing edge flap acts similarly to an aileron; however, it, as opposed to an aileron, can be retracted partially into the wing if not used.

CONCLUSION

10. A Flying Cadet should have thorough knowledge of Aerofoil and types of Aerofoils. It is the basic structure of ac which supports ac in air.

PRINCIPLE OF FLIGHT - FORCES ACTING ON AIRCRAFT
(PF-6)

Period -- I
 Type -- Lecture
 Term -- I/III
 Revised by --

Trg Aids

12. Computer slides, pointer, black board and chalk.

Time Plan

13. (a)	Intro	-	05 mins
(b)	Stalling	-	30 mins
(c)	Conclusion	-	05 mins
	Total	-	40 Mins

“It is possible to fly without motors, but not without knowledge and skill.”-

Wilbur Wright

INTRO

(Slide 01)

14. An Aircraft is considered to be in straight and level flight when it is flying at a constant altitude and speed, maintaining lateral level and direction. Force acting on aircraft and any given movement are Lift, Drag, Thrust and Weight.

AIM

(Slide 02)

15. To teach Flying Cadets about Bernoulli’s Principle and Venturi Effect.

PREVIEW

(Slide 03)

5. The class will be conducted in the following parts:-

- (a) Lift (b) Drag (c) Thrust (d) Weight

FORCES ACTING ON AIRCRAFT

(Slide 04)

6. **Lift** is a positive force caused by the difference in air pressure under and above a wing. The higher air pressure beneath a wing creates lift, and is affected by the shape of the wing. Changing a wing's angle of attack affects the speed of the air flowing over the wing and the amount of lift that the wing creates.
7. **Weight** is the force that causes objects to fall downwards. In flight, the force of weight is countered by the forces of lift and thrust.
8. **Thrust** is the force that propels an object forward. An engine spinning a propeller or a jet engine expelling hot air out the tailpipe are examples of thrust. In bats, thrust is created by muscles making the wings flap.
9. **Drag** is the resistance of the air to anything moving through it. Different wing shapes greatly affect drag. Air divides smoothly around a wing's rounded leading edge, and flows neatly off its tapered trailing edge...this is called streamlining.

**CONCLUSION**

10. The flying cadets should thoroughly understanding the above basic concepts of level flight for better understanding of aerodynamics.

PRINCIPLE OF FLIGHT – LIFT & DRAG
(PF-7)

Period -- I
 Type -- Lecture
 Term -- II/I
 Revised by --

Trg Aids

16. Computer slides, pointer, black board and chalk.

Time Plan

17.	(a)	Intro	-	05 mins
	(b)	Stalling	-	30 mins
	(c)	Conclusion	-	05 mins
		Total	-	40 Mins

“What is chiefly needed is skill rather than machinery.”- Wilbur Wright

INTRO

(Slide 01)

3. Lift and Drag are the most important components of aircraft in level flight. They act in 90^0 to each other. The Lift component of aircraft supports the aircraft in air whereas the drag resist the air craft movement in air.

AIM

(Slide 02)

7. To teach Flying Cadets about effects of Lift & Drag on the ac.

PREVIEW

(Slide 03)

5. The class will be conducted in the following parts:-

(a) Lift (b) Drag

LIFT& DRAG

(Slide 04)

6. **Lift** is a positive force caused by the difference in air pressure under and above a wing. The higher air pressure beneath a wing creates lift, and is affected by the shape of the wing. Changing a wing's angle of attack affects the speed of the air flowing over the wing and the amount of lift that the wing creates. The lift forces act vertically up 90° to the direct of flight.

7. **Drag** is the resistance of the air to anything moving through it. Different wing shapes greatly affect drag. Air divides smoothly around a wing's rounded leading edge, and flows neatly off its tapered trailing edge this is called streamlining. Drag forces act parallel and opposite to the direction of flight.

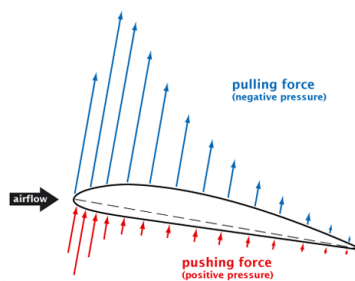
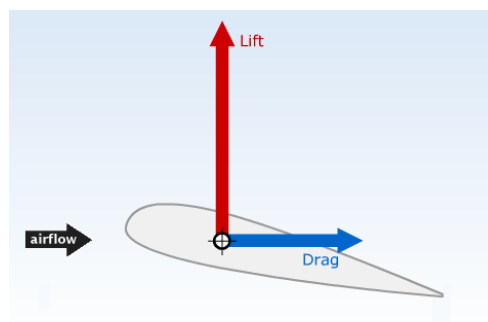
**CONCLUSION**

The flying cadets should thoroughly understand the above basic concepts of level flight for better understanding of aerodynamics.

PRINCIPLE OF FLIGHT – FLAP & SLATS
(PF-8)

Period	--	I
Type	--	Lecture
Term	--	II/III
Revised by	--	

Trg Aids

18. Computer slides, pointer, black board and chalk.

Time Plan

19.	(a)	Intro	-	05 mins
	(b)	Stalling	-	30 mins
	(c)	Conclusion	-	05 mins
		Total	-	40 Mins

“More than anything else the sensation is one of perfect peace mingled with an excitement that strains every nerve to the utmost, if you can conceive of such a combination.”-

Wilbur Wright

INTRO

(Slide 01)

1. Flaps are hinged surfaces mounted on the trailing edges of the wings of a fixed-wing aircraft to reduce the speed at which an aircraft can be safely flown and to increase the angle of descent for landing. They shorten takeoff and landing distances. Flaps do this by lowering the stall speed and increasing the drag.

2. Slats are aerodynamic surfaces on the leading edge of the wings of fixed-wing aircraft which, when deployed, allow the wing to operate at a higher angle of attack. A higher coefficient of lift is produced as a result of angle of attack and speed, so by deploying slats an aircraft can fly at slower speeds, or take off and land in shorter distances. They are usually used while landing or performing maneuvers which take the aircraft close to the stall, but are usually retracted in normal flight to minimize drag.



AIM (Slide 02)

3. To teach Flying Cadets about Flaps & Slats of an ac.

PREVIEW (Slide 03)

4. The class will be conducted in the following parts:-
- (a) Flaps
 - (b) Types of Flaps
 - (c) Slats
 - (d) Types of Slats

FLAPS (Slide 04)

4. The general airplane lift equation:

$$L = \frac{1}{2}\rho V^2 SC_L$$

where:

- L is the amount of *Lift* produced,
- ρ is the air density,
- V is the indicated airspeed of the airplane or the *Velocity* of the airplane, relative to the air
- S is the planform area or *Surface area* of the wing and

- C_L is the *lift coefficient* which is determined by the camber of the airfoil used, the chord of the wing and the angle at which the wing meets the air (or angle of attack).

Here, it can be seen that increasing the area (S) and lift coefficient (C_L) allow a similar amount of lift to be generated at a lower airspeed (V).

5. Extending the flaps also increases the drag coefficient of the aircraft. Therefore, for any given weight and airspeed, flaps increase the drag force. Flaps increase the drag coefficient of an aircraft because of higher induced drag caused by the distorted span wise lift distribution on the wing with flaps extended. Some flaps increase the plan form area of the wing and, for any given speed, this also increases the parasitic drag component of total drag.

Types of Flaps:

6. **Plain flap:** the rear portion of airfoil rotates downwards on a simple hinge mounted at the front of the flap. Due to the greater efficiency of other flap types, the plain flap is normally only used where simplicity is required. A modern variation on the plain flap exploits the ability of composites to be designed to be rigid in one direction, while flexible in another. When such a material forms the skin of the wing, its camber can be altered by the geometry of the internal supporting structure, allowing such a surface to be used either as a flap or as an aileron.

7. **Split flap:** the rear portion of the lower surface of the airfoil hinges downwards from the leading edge of the flap, while the upper surface stays immobile. Like the plain flap, this can cause large changes in longitudinal trim, pitching the nose either down or up, and tends to produce more drag than lift. At full deflection, a split flaps acts much like a spoiler, producing lots of drag and little or no lift.

8. **Slotted flap:** a gap between the flap and the wing forces high pressure air from below the wing over the flap helping the airflow remain attached to the flap, increasing lift compared to a split flap. Additionally, lift across the entire chord of the primary airfoil is greatly increased as the velocity of air leaving its trailing edge is raised, from the typical non-flap 80% of free stream, to that of the higher-speed, lower-pressure air flowing around the leading edge of the slotted flap. Any flap that allows air to pass between the wing and the flap is considered a slotted flap.

9. **Fowler flap:** split flap that slides backwards flat, before hinging downwards, thereby increasing first chord, then camber. The flap may form part of the upper surface of the wing, like a plain flap, or it may not, like a split flap but it must slide rearward before lowering. It may provide some slot effect but this is not a defining feature of the type.

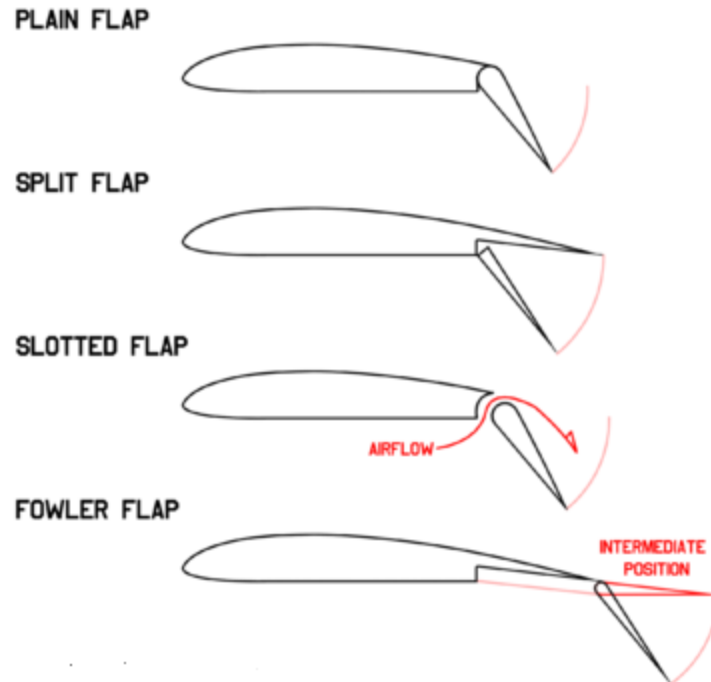

SLATS

(Slide 04)

10. **Slats**: The chord of the slat is typically only a few percent of the wing chord. The slats may extend over the outer third of the wing, or they may cover the entire leading edge. The slat does not give the air in the slot high velocity (it actually reduces its velocity) and also it cannot be called high-energy air since all the air outside the actual boundary layers has the same total heat. The actual effects of the slat are

Types of Slats:

11. **Automatic** - the slat lies flush with the wing leading edge until reduced aerodynamic forces allow it to extend by way of aerodynamics when needed. Sometimes referred to as Handley-Page slats.

12. **Fixed** - the slat is permanently extended. This is sometimes used on specialist low-speed aircraft (these are referred to as slots) or when simplicity takes precedence over speed.

13. **Powered** - the slat extension can be controlled by the pilot. This is commonly used on airliners.

PRINCIPLE OF FLIGHT – STALLING
(PF-9)

Period -- I
Type -- Lecture
Term -- II/IV
Revised by --

Trg Aids

20. Computer slides, pointer, black board and chalk.

Time Plan

21.	(a)	Intro	-	05 mins
	(b)	Stalling	-	30 mins
	(c)	Conclusion	-	05 mins
		Total	-	40 Mins

“The Wright brothers flew through the smoke screen of impossibility.”-
DortheaBrande

INTRO

(Slide 01)

1. **Astall** is a reduction in the lift coefficient generated by a foil as angle of attack increases. This occurs when the critical angle of attack of the foil is exceeded. The critical angle of attack is typically about 15 degrees, but it may vary significantly depending on the fluid, foil, and Reynolds number.

2. Stalls in fixed-wing flight are often experienced as a sudden reduction in lift as the pilot increases angle of attack and exceeds the critical angle of attack (which may be due to slowing down below stall speed in level flight). A stall does not mean that the engine(s) have stopped working, or that the aircraft has stopped moving — the effect is the same even in an unpowered glider aircraft.

AIM

(Slide 02)

4. To teach Flying Cadets about stalling of an ac.

PREVIEW (Slide 03)

3. The class will be conducted in the following parts:-
- (a) Stalling
 - (b) Stalling Speed

STALL (Slide 04)

4. A **stall** is a condition in aerodynamics and aviation wherein the angle of attack increases beyond a certain point such that the lift begins to decrease. The angle at which this occurs is called the *critical angle of attack*. This critical angle is dependent upon the profile of the wing, its platform, its aspect ratio, and other factors, but is typically in the range of 8 to 20 degrees relative to the incoming wind for most subsonic airfoils. The critical angle of attack is the angle of attack on the lift coefficient versus angle-of-attack curve at which the maximum lift coefficient occurs.

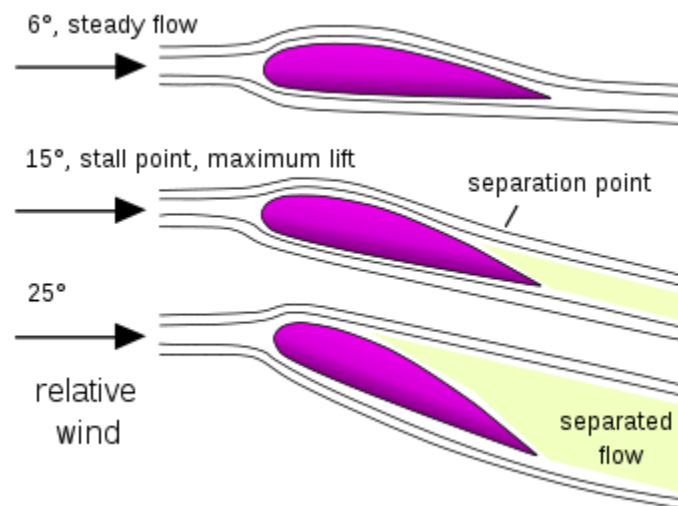

5. Flow separation *begins* to occur at small angles of attack while *attached* flow over the wing is still dominant. As angle of attack increases, the separated regions on the top of the wing increase in size and hinder the wing's ability to create lift. At the critical angle of attack, separated flow is so dominant that further increases in angle of attack produce *less* lift and vastly more drag.

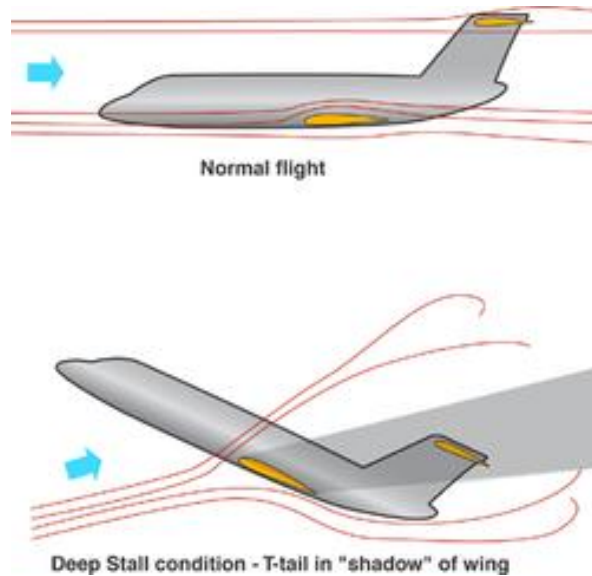

6. A fixed-wing aircraft during a stall may experience buffeting or a change in attitude. Most aircraft are designed to have a gradual stall with characteristics that will warn the pilot and give the pilot time to react. For example, an aircraft that does not buffet before the stall may have an audible alarm or a stick shaker installed to simulate the feel of a buffet by vibrating the stick fore and aft. The "buffet margin" is, for a given set of conditions, the amount of 'g', which can be imposed for a given level of buffet. The critical angle of attack in steady straight and level flight can be attained only at low airspeed. Attempts to increase the angle of attack at higher airspeeds can cause a high-speed stall or may merely cause the aircraft to climb.

7. **Stalling Speed:** Stalls depend only on angle of attack, not airspeed. Because a correlation with airspeed exists, however, a "stall speed" is usually used in practice. It is the speed below which the airplane cannot create enough lift to sustain its weight in 1g flight. In steady, unaccelerated (1g) flight, the faster an airplane goes, the less angle of attack it needs to hold the airplane up (i.e., to produce lift equal to weight). As the airplane slows down, it must increase angle of attack to create the same lift (equal to weight). As the speed slows further, at some point the angle of attack will be equal to the critical (stall) angle of attack. This speed is called the "stall speed". The angle of attack cannot be increased to get more lift at this point and so slowing below the stall speed will result in a descent. And, so, airspeed is often used as an indirect indicator of approaching stall conditions. The stall speed will vary depending on the airplane's weight, altitude, and configuration (flap setting, etc.)

CONCLUSION

The cadets should have a deep understanding of the factors leading to Stall and the stall characteristics so has to understand critical angle of attack, stalling speed and recovery procedures.

PRINCIPLE OF FLIGHT – THRUST**(PF-10)**

Period	--	I
Type	--	Lecture
Term	--	III/II

Revised by --

Trg Aids

22. Computer slides, pointer, black board and chalk.

Time Plan

23.	(a)	Intro	-	05 mins
	(b)	Thrust	-	30 mins
	(c)	Conclusion	-	05 mins
		Total	-	40 Mins

“The desire to fly is an idea handed down to us by our ancestors who, in their grueling travels across trackless lands in prehistoric times, looked enviously on the birds soaring freely through space, at full speed, above all obstacles, on the infinite highway of the air.”- Wilbur Wright

INTRO

(Slide 01)

1. **Thrust** is a reaction force described quantitatively by Newton's second and third laws. When a system expels or accelerates mass in one direction, the accelerated mass will cause a force of equal magnitude but opposite direction on that system. The force applied on a surface in a direction perpendicular or normal to the surface is called thrust.

2. **Propeller** A propeller converts shaft power from the engine into thrust. It does this by accelerating a mass of air rearwards. Thrust from the propeller is equal to the mass of air accelerated rearwards multiplied by the acceleration given to it. A mass is accelerated rearwards and the equal and opposite reaction drives the aircraft forwards

AIM

(Slide 02)

3. To make Flying Cadets conversant with thrust, one of the forces acting on the aircraft during flying.

PREVIEW

(Slide 03)

4. The class will be conducted in the following parts:-

- (a) Thrust
- (b) Propeller

THRUST

(Slide 04)

5. Thrust is the force which moves an aircraft through the air. Thrust is used to overcome the drag of an airplane. Thrust is generated by the **engines** of the aircraft through some kind of propulsion system.

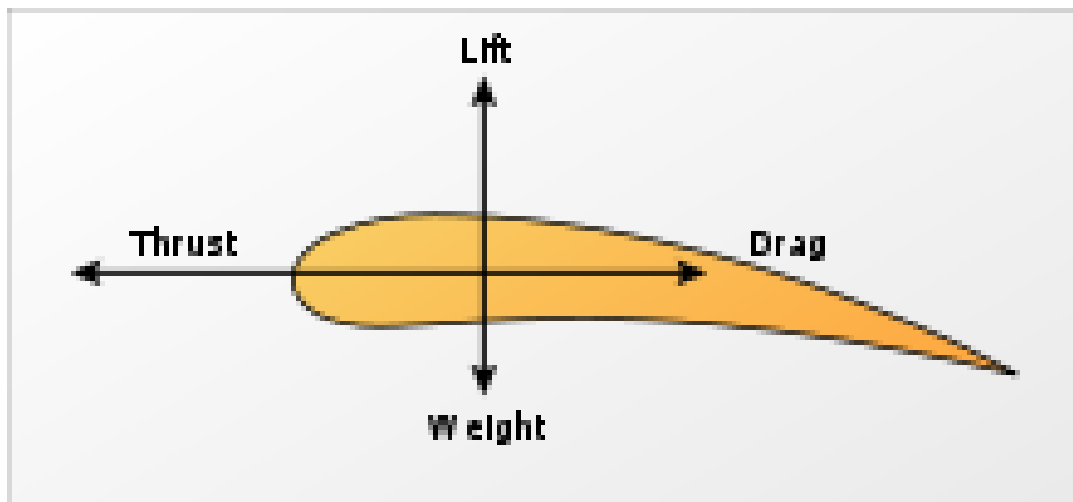

6. Thrust is a mechanical force, so the propulsion system must be in physical contact with a **working fluid** to produce thrust. Thrust is generated most often through the reaction of accelerating a mass of gas. Since thrust is a force, it is a vector quantity having both a magnitude and a direction. The engine does work on the gas and accelerates the gas to the rear of the engine; the thrust is generated in the **opposite direction** from the accelerated gas. The magnitude of the thrust depends on the amount of gas that is accelerated and on the difference in velocity of the gas through the engine.

7. To accelerate the gas, we have to expend energy. The energy is generated as heat by the combustion of some fuel. The thrust equation describes how the acceleration of the gas produces a force. The type of propulsion system used on an aircraft may vary from airplane to airplane and each device produces thrust in a slightly different way. We will discuss four principal propulsion systems at this web site; the propeller, the turbine or jet, engine, the ramjet, and the rocket.

PROPELLER

8. The propeller blade is an aerofoil and the definitions for chord, camber, thickness/chord ratio and aspect ratio are the same as those given previously for the wing. Additionally the following must be considered.

(i) **BLADE ANGLE or PITCH:**

The angle between the blade chord and the plane of rotation. Blade angle decreases from the root to the tip of the blade (twist) because rotational velocity of the blade increases from root to tip. For reference purposes, the blade angle is measured at a point 75% of the blade length from the root.



(ii) **GEOMETRIC PITCH:**

The geometric pitch is the distance the propeller would travel forward in one complete revolution if it were moving through the air at the blade angle. (It might help to imagine the geometric pitch as a screw thread, but do not take this "screw" analogy any further).

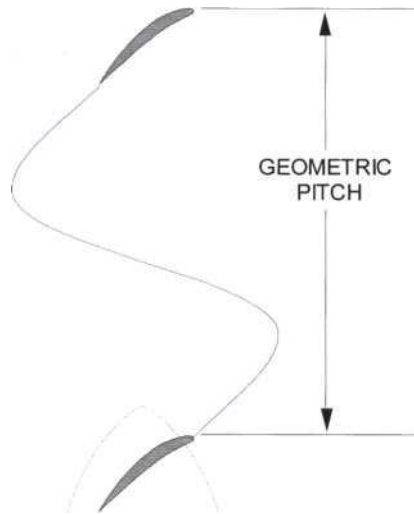

(iii) **ANGLE OF ATTACK:**

The path of the propeller through the air determines the direction of the relative airflow. The angle between the blade chord and the relative airflow is the angle of attack. The angle of attack is the result of propeller rotational velocity (RPM) and aircraft forward velocity (TAS).

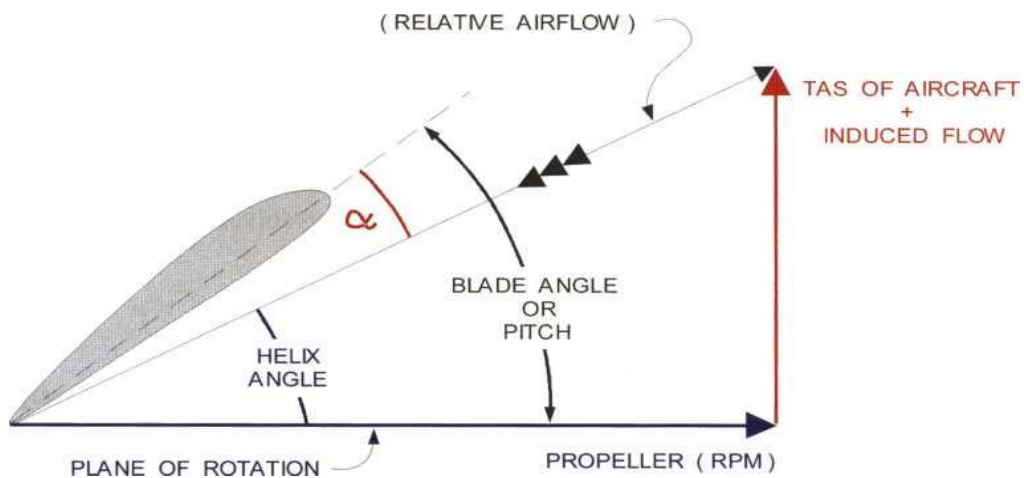

CHAPTER – VI

AIRMANSHIP

AIRMANSHIP**INTRODUCTION****(AR-1)**

Period	-	I
Type	-	Lecture
Term	-	I Year
Revised by	-	

Training Aids

1. Computer slides, pointer, black board and chalk.

Time Plan

2. (a)	Introduction	- 05 minute
(b)	Importance	- 10 minute
(c)	Basic Terminologies	- 20 minute
(d)	Conclusion	- 05 minute
	Total	40 Minute

INTRODUCTION

(Slide-1)

1. Airmanship is a study of rules and regulations which must be followed both on the ground and in air to ensure safety and proper discipline in flying. It, thus, includes all air traffic control procedures and other actions laid down to deal with any type of aircraft emergencies, and other contingencies.

AIM

(Slide 2)

3. To teach the cadets about Airmanship and its basic terminologies.

3. **IMPORTANCE OF AIRMANSHIP**

(Slide-3)

- (a) Airmanship helps to inculcate the sense of discipline amongst pilots and other crew members.
- (b) It helps the pilot to know the standard procedures laid down for the airfield on which he is operating.
- (c) It helps the pilot to know procedure to be followed in emergency situation.
- (d) Finally, airmanship when studied in correct sense promotes flight safety and prevents aircraft accidents.
- (e) Good airmanship ensures a pilot at his best, when the situation is at its worst.

BASIC TERMINOLOGIES

(Slide 4-9)

- 4. **Aerodrome.** A defined area on land or water including any buildings, installations and equipment intended to be used either wholly or in part for the arrival, departure and movement of ac.
- 5. **Airfield:** The airfield refers to an area of land used for takeoff and landing of aircraft and excludes buildings and installations.
- 6. **Airport:** The word airport is mainly used for civil flying establishments which handle international air traffic and, therefore, have a custom house, other travel amenities – port facilities in fact.
- 7. **Aerodrome Reference Point (ARP).** It is a designated geographical location of an aerodrome, normally taken as the geometrical centre of the runways or runway in the case of a single runway aerodrome. The ARP is defined in degrees, minutes and seconds of latitude and longitude.
- 8. **Aerodrome Traffic Zone.** The airspace extending from an aerodrome to a height of 2000 ft above the level of the aerodrome and within a distance of 1 ½ nm of its boundaries; except any part of that airspace which is within the aerodrome traffic zone of another aerodrome which is notified as being the controlling aerodrome is called the Aerodrome Traffic Zone.
- 9. **Aircraft Classification Number (ACN).** The ACN is a number expressing the relative effect of an ac load on a pavement for specified sub-grade strength.
- 10. **Air Defence Identification Zone.** Airspace of defined dimensions within which the ready identification, location and control of ac is required.
- 11. **Air Report.** It is a report passed during the course of a flight in conformity with requirements for position, operational, or meteorological reporting in the AIREP or POMAR forms.

12. **Air Route.** The navigable airspace between two points, identified to the extent necessary for the application of flight rules.
13. **Air Traffic Advisory Service.** Service provided to ensure separation in-so-far as possible between ac which are operating on an IFR flight plan, outside control areas but within advisory routes or advisory areas.
14. **Air Traffic Control Centre.** An organisation established to provide:
 - (a) Air traffic control within a control area (where established).
 - (b) Flight information service within a flight information region.
 - (c) Alerting service for search and rescue within its flight information region.
15. **Air Traffic Control Clearance.** Authorisation for an aircraft to proceed under conditions specified by an air traffic control unit.
16. **Air Traffic Control Services.** A service provided for the purpose of:
 - (a) Preventing collisions between ac in the air, and on the manoeuvring area between a/c and obstructions.
 - (b) Expediting and maintaining an orderly flow of traffic. Air Traffic Control Services are provided by licensed Air Traffic Controllers. The call sign suffixes, TOWER, APPROACH, GROUND, DIRECTOR, ZONE, and RADAR are used as appropriate.
17. **Airway.** A control area or portion thereof established in the form of a corridor equipped with radio navigational aids.
18. **Heading.** The direction in which the longitudinal axis of an aircraft is pointed usually expressed in degrees from North (magnetic).
19. **Height.** The vertical distance of a level, a point or an object considered as appoint, measured from a specified datum.
20. **Holding Point.** A point specifically located, identified by visual or other means in the vicinity of which the position of an aircraft in flight is maintained in accordance with air traffic control instructions.
21. **Load Classification Number (LCN).**The bearing strength of a pavement or runway is defined by a number. This is associated with an indication of the characteristics and type of construction of the pavement
22. **Prohibited Area.** Airspace of defined dimensions, above the land areas of territorial waters of a State, within which the flight of aircraft is prohibited.

23. **Restricted Area:** An airspace of defined dimensions, above the land areas or territorial waters of a State, within which the flight of aircraft is restricted in accordance with specified conditions.
24. **QFE.** Aerodrome pressure corrected for temperature. When set on the altimeter on the ground, the Altimeter should read zero.
25. **Transition Altitude (TA).** The altitude in the vicinity of an aerodrome at or below which the Vertical position of an aircraft is controlled by reference to altitudes above mean sea level or height above the aerodrome depending on whether QNH or QFE is set on the altimeter.
26. **Transition Layer.** The airspace between the transition altitude and the transition level. The depth of the layer will normally be insignificant, and will in any case never exceed 500 ft.
27. **Transition Level.** The lowest flight level above the transition altitude. It will vary in accordance with the relationship between the QNE and the standard pressure datum.
28. **Visibility.** The ability, as determined by atmospheric conditions and expressed in units of distance, to see and identify prominent lighted objects by night.
29. **QNH** Aerodrome pressure corrected for temperature and adjusted to Mean Sea Level, using the ICAO formula. When set on the altimeter on the ground, the altimeter should read aerodrome elevation.
30. **Alerting Service:** A service provided to notify appropriate organizations regarding ac in need of search and rescue aid, and assist such organizations as required.
31. **Alternate Aerodrome.** An aerodrome specified in the flight plan to which a flight may proceed when it becomes inadvisable to land at the aerodrome of intended landing.
32. **Altitude.** The vertical distance of a level, a point or object considered as a point measured from mean sea level (MSL).
33. **Ceiling.** The height above ground or water of the base of the lowest layer of cloud below 6,000 meters (20,000') covering more than half the sky.
34. **Danger Area.** An airspace of defined dimensions within which activities dangerous to the flight on ground manoeuvring of ac may exist at specified times.

35. **Distress Message.** Emergency message to be used when an aircraft is threatened by serious or imminent danger and the crew is in need of immediate assistance.
36. **Elevation.** The vertical position of a point or a level, above, on or affixed to the surface of the earth, measured from mean sea level.
37. **Estimated Time of Arrival (ETA).** For IFR flights, the time at which it is estimated that the ac will arrive over a designed point, defined by reference to navigation aids, from which it is intended that an instrument approach procedure will be commenced, or, if no navigational aid is associated with the aerodrome, the time at which the ac will arrive overhead. For VFR flights, it is the time at which it is estimated that the ac will arrive over the aerodrome.
38. **Flight Level.** A surface of constant atmospheric pressure which is related to a specific pressure datum 1013.2 mb (1013.2 hectopascals (hPa) 29.92 inches of mercury), and is separated from other such surfaces by specific pressure intervals.

Notes.A pressure type altimeter calibrated in accordance with the Standard Atmosphere.

- (a) When set to a QNH, altimeter setting will indicate altitude.
- (b) When set to a QFE, altimeter setting will indicate height above the QFE reference datum.
- (c) When set to a pressure of 1013.2 mb (1013.2 hPa, 29.92 ins Hg) the altimeter may be used to indicate flight levels.
- (d) The terms 'height' and 'altitude' used in Note 1 above indicate altimetric rather than geometric heights and altitudes.
- (e) No altimeter correction is to be applied when setting altimeter to 1013.2 hPa (QNE) to fly the flight levels.

39. **Flight Plan.** Specified information provided to Air Traffic Service Units, relative to the intended flight or portion of a flight of an ac.

CONCLUSION

Slide-10

40. Importance of airmanship cannot be overemphasized. It is mandatory for all the pilots to be aware about their own aircraft and the environment in which they operate before they get airborne every time. The basic terminologies covered in this lesson can be said to be drop in the ocean and enumerated to provide basic insight about the terms used in the aviation field. Therefore the endeavour of all the pilots should be to gain full knowledge about the aviation environment in which they operate to observe maximum safety at all times.

AIRFIELD LAYOUT**(AR-2)**

Period	-	II
Type	-	Lecture
Term	-	I Year
Revised by	-	

Training Aids

1. Computer slides, pointer, black board and chalk.

Time Plan

2. (a)	Introduction	-	05 minute
(b)	Requirement	-	05 minute
(c)	Different Parts of Runway	-	20 minute
(d)	Runway markings	-	05 minute
(e)	Conclusion	-	05 minute
	Total		40 Minute

INTRODUCTION

(Slide-1)

1. The sitting, layout and physical characteristics of an airfield should facilitate safe, orderly and expeditious flow of air traffic. The basic areas associated with physical characteristics have been standardised for all airfields/aerodromes with subsequent amendments from time to time. The standardised physical characteristics have been worked out considering most of the aircraft available today and standardised by DGCA conforming to international rules and regulations.

AIM

(Slide-2)

2. To teach the cadets about the layout of an Aerodrome and its markings.

LAYOUT OF AERODROMES/AIRFIELDS

(Slide 3-6)

3. Following are the areas laid down at the airfields to facilitate safe and expeditious conduct of aircraft operations:

(a) **Movement Areas.** Movement areas are that part of an airfield intended for the surface movement of the aircraft. These are paved areas and include runways, taxiways, dispersal areas, aprons.

(b) **Flight Strip.** It is the rectangular portion of an airfield containing the runway and paved over-runs along with the shoulders and cleared zones

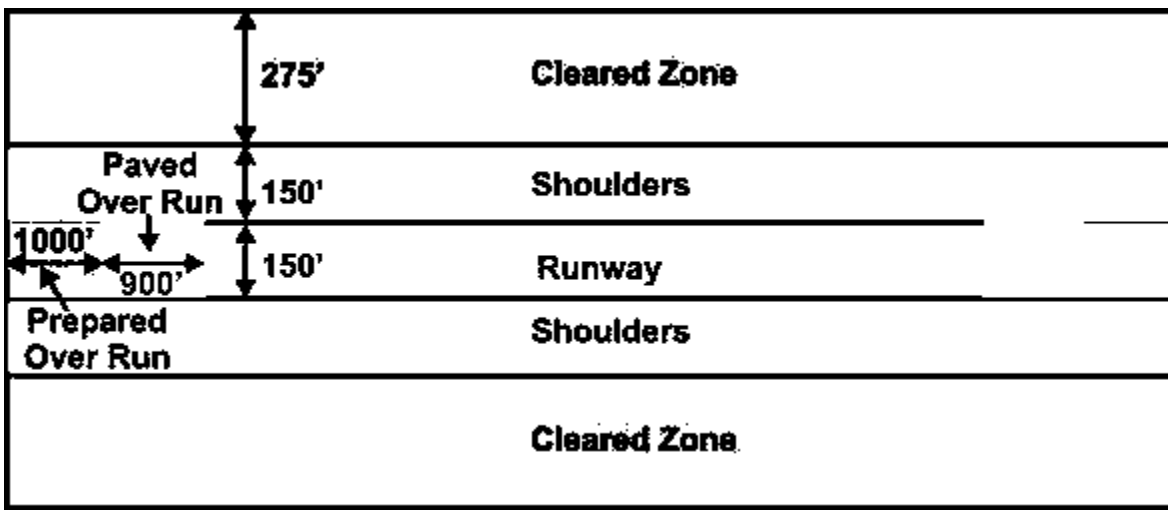

(c) **Runways.** Runways are paved surfaces intended for take-off and landing run of ac. The number and orientation of runways at an airfield will depend upon the volume of traffic, runway occupancy time and climatological data on surface winds.

(d) **Taxiways.** These are paved surfaces provided for the taxiing of aircraft and intended to provide a link between one part of the aerodrome and another.

(e) **Shoulders.** These are areas immediately adjacent to the edges of the runway, taxiways, over-runs and SGAs prepared for accidental or emergency use in the event of an aircraft running off the paved surface.

(f) **Cleared Zones.** These are those areas of the flight strip adjacent to the shoulders which for safety of aircraft operations, should be levelled and be free of obstructions as far as possible.

(g) **Over-Run Areas.** A defined rectangular area on ground at the end of runway in the direction of take-off prepared as a suitable area in which an aircraft can be stopped in case of abandoned take off, or during a landing emergency.

AERODROME MARKINGS

(Slide 7-10)

4. Aerodrome markings consist of signs on surface of movement areas to convey aeronautical information.

5. Aerodrome ground markings shall consist of the following:
 - (a) Runway markings.
 - (b) Taxiway markings.
 - (c) Unserviceability markings.

Runway Markings

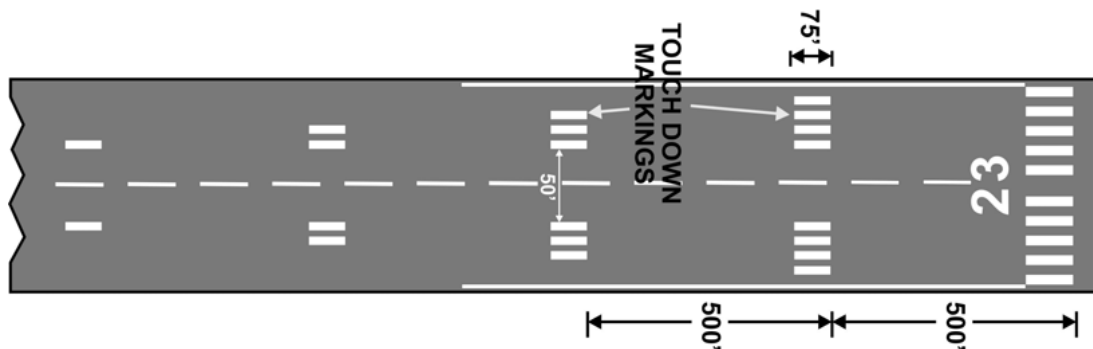

6. Runway markings shall consist of:
 - (a) **Runway designation markings.** Runway designation markings shall consist of a two-digit number and on parallel runways shall be supplemented by a letter. The two-digit number shall be the whole number nearest to one tenth of magnetic azimuth of centre line measured clockwise from magnetic North when viewed from direction of approach.

 - (b) **Runway centre line markings.** Runway centre line markings shall consist of a series of broken longitudinal lines along the runway centre line and extending along the whole length of the runway

 - (c) **Runway threshold markings.** The markings shall consist of a series of longitudinal strips of uniform dimensions symmetrically placed on both sides of runway centre line and extending laterally to 1.5 m (5 ft) from the edge of runway.

 - (d) **Runway touch down zone markings.** Touch down zone markings shall be located over the first 600 m (2000 ft) of instrument runways at longitudinal spacing of 150 m (500 ft). These markings shall be provided with distance coding

(i) **Runway side strip markings.** Side strip markings shall be provided on all paved runways. These markings shall consist of two lines extending the whole length of the runway parallel to and equidistant from runway centre line

7. **Taxiway Markings** These markings shall consist of:
 (a) Taxiway centre line markings.
 (b) Runway holding position markings.

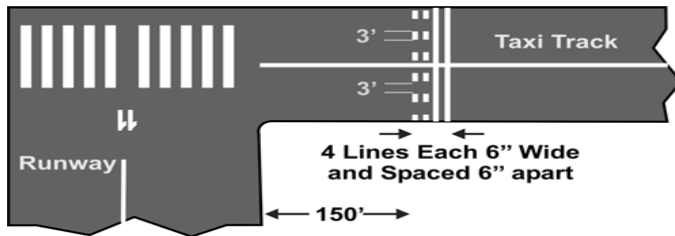

8. **Taxiway Centre Line Markings.** These markings shall be single unbroken lines 0.15 m (6") wide along the centre line of taxiway.

9. **Runway Holding Position Markings.** These markings shall consist of four lines of 0.15 m (6") width each with spacing of 0.15 m (6").

Unserviceability Markings

10. Unserviceability markings shall be displayed on those parts of movement area, which are unfit for landing, take-off or surface movement of aircraft. Unserviceability markings shall be in the form of a cross as given below

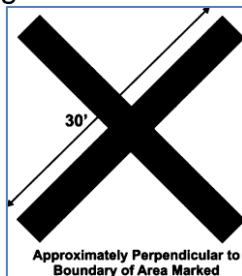

Aerodrome lighting: there are several types of approach and airfield lighting in use in the service. All permanent installations are normally on the mains electricity supply but also have some alternative arrangements for use in the event of power failure. Aerodrome lighting is considered under two headings.

(a) **Approach lighting:** this is to assist the pilots to make an approach for landing in poor visibility or at night.

(b) **Airfield lightings:** modern installation consist of raised high intensity white lights along each side of the runway, beamed towards the landing aircraft. At the beginning of runway, called the thresh hold, is a bar of green lights going across the full width of the runway.

CONCLUSION

(Slide-11)

11. The concept of airfields has changed considerably since the early days of flying. The aircraft of yester years needed comparatively small, level grass areas. When these airfields were built, the number of cross wind landing was reduced by building a triangular pattern of three runways, the longest of which was usually in line with the prevailing winds. But as the aircraft became faster, their landing and take-off runs became longer and the airfields had to be enlarged to meet their ends. With faster approach and landing speeds of aircraft, the lengths of runway became more important factor than the wind direction. The modern tendency, therefore, is for operations to be confined to one or at the most two runways on the each airfield. The longest of these runways is usually designed for instrument landings in bad weather and it is known as instrument runway having full, lighting, radio, radar and instrument landing facilities .Today the runways are even more than 6000 yds long and 200 ft wide and constructed of concrete surface with asphalt to give a clean and smooth operating surface.

RULES OF THE AIR**(AR-3)**

Period	-	V
Type	-	Lecture
Term	-	I Year
Revised by	-	

Training Aids

1. Computerslides, pointer, White board, Marker pen and Duster.

Time Plan

2.	(a)	Introduction	- 05 minutes
	(b)	Visual Flight Rules	- 10 minutes
	(c)	Instruments Flight Rules	- 05 minutes
	(d)	Right of way rule	-05 minutes
	(e)	Circuit rules	- 05 minutes
	(d)	Conclusion	- 05 minutes
		Total	40 Minute

INTRODUCTION

(Slide 1)

1 Flying, in general is of a complex nature, therefore there are many rules and regulations which must be observed by pilots and air traffic control personnel alike if the maximum degree of safety is to be ensured to aircraft, flying personnel, civilians and property.

AIM

(Slide 2)

To acquaint the cadets with the Rules of the Air during flying.

VISUAL FLIGHT RULES

(Slide 3-7)

2. **Visual Meteorological Conditions:** Visual Meteorological Conditions are said to exist when the prevailing visibility, distance from cloud, and ceiling are equal to or better than the specified minimum. In Flight the criteria are:
 - (a) Visibility: 5 nm / 8 km.
 - (b) Distance from cloud: 200 yards / 1.5 km horizontally and 1000 feet / 200 meters vertically.

3. **Applicability:** Unless authorised by the appropriate ATS authority, VFR flight shall not be operated:
 - (a) Between sunset and sunrise.
 - (b) Above FL 200 (above flight level 150 in South East Asia).
 - (c) At transonic and supersonic speeds.
 - (d) When operating more that 100 nm seaward from the shoreline within controlled airspace.

3. **Minimum Heights:** Except when necessary for take-off or landing, or except by permission from the appropriate authority, a VFR flight shall not be flown:
 - (a) Over the congested area of cities, towns or settlements or over an open air assembly or persons at height less than 1000 feet (300 meters) above the highest obstacle within a radius of 2000 ft (600 meters) from the aircraft.
 - (b) Elsewhere than as specified above, at a height less than 500 feet (150 meters) above the ground or water.

4. **Rules Governing Take-Off and Landing:** VFR flights shall not take off or land at an aerodrome or enter the aerodrome traffic zone/pattern when the ground visibility and or the cloud ceiling are less than that specified for VMC in the laid down orders.

5. **Special VFR Flights:** VFR Flights, specially authorised can be permitted even in weather conditions below VMC, subject to obtaining ATC clearance. Such flights are known as special VFR flights.

6. **Inflight Operation:** VFR Flight shall be flown only in condition of visibility and distance from clouds equal to or greater than those specified for VMC in the laid down orders.

7. **Restrictions:** VFR Flights except those operated in the immediate vicinity of the aerodrome, shall not be operated
 - (a) At night.
 - (b) Above flight level 200 (above flight level 150 in South East Asia)
 - (c) More than 100 nm seawards from the shoreline in controlled air space.

8. **Minimum Heights:** Except for landing take off or by prior permission of appropriate authority, VFR flights shall not be flown:

(a) At a heights less than 1000 feet (300 meters) above the highest obstacle within a radius of 2000 feet (600 meters) from the aircraft, over congested areas of cities settlements or over an open air assembly of persons.

(b) Elsewhere than, as specified in (a) above, at a height of less than 500 feet (150 meters) above ground or water.

9. **Cruising Levels – General:** VFR flights, in level cruising phase, operated above 3000 feet from ground or water shall be conducted at a flight level appropriate to the track in accordance with system of cruising levels prescribed for Indian Airspace in the AIP and DGCA circulars.

10. **VFR Flights in Controlled Air Space (instrument Visual):**VFR flights conducted in controlled airspace (instruments visual) shall select cruising levels- used by IFR flights in accordance with the system of cruising level prescribed by DGCA through NOTAMS except that correlation of levels to track shall not apply when indicated in ATC clearances.

11. **Compliance with Instructions:** VFR flights shall comply with the provisions of ATC services as laid down in general flights rule

(a) When forming part of aerodrome traffic at controlled aerodromes.

(b) When operated as special VFR flights.

(c) When operated in controlled airspace (instrument visual).

12. **Change from VFR to IFR:**A VFR flight when electing to change to IFR shall:

(a) Communicate the necessary changes to be effected to its current flight plan or;

(b) Submit a flight plan to the appropriate ATS unit and obtain clearance prior to changing over the IFR flight when in controlled airspace.

13. A pilot may be allowed to fly in accordance with the instrument flight rules in visual meteorological conditions.

14. Compliance with instruments flight rules is compulsory under the following circumstances although the flights are operated in visual meteorological conditions:

(a) When operated during night with exception of such local flights as may be exempted by the Air Traffic Control. For this purpose, the local flight is wholly conducted in the immediate vicinity of the aerodrome.

(b) When operated more than 100 nm seaward from the coast-line in controlled airspaces.

INSTRUMENTS FLIGHT RULES

(Slide 8-10)

15. **Aircraft Equipment:** Aircraft shall be equipped with suitable instruments and with navigational aids appropriate to the route to be flown.
16. **Minimum Levels.** Except for take off or landing or when specifically authorised by the appropriate authority, an IFR flight shall be flown at a level not below the minimum flight altitude established by DGCA in India or where no such minimum flight altitude has been established at:(a) Over a high terrain or in mountainous areas, at a level which is at least 600 meters (2000 feet) above the highest obstacle located within 8 km of the estimated position of the aircraft.
(b) Elsewhere at a level which is at least 300 meters (1000 feet) above the highest obstacle located within 8 km of the estimated position of the aircraft.
17. **Change from IFR Flight to VFR Flight.** An IFR flight electing to change to Visual Flight Rules, shall notify the appropriate unit, specifically, that the IFR flight is cancelled and communicate the change to be made to its current flight plan.
18. **Rules Applicable to IFR Flights within Controlled Airspace.** IFR flights shall comply with the provisions of ATC instructions as specified in the general rules. The cruising levels to be used by IFR flights for operation in controlled airspace shall be in accordance with the system of cruising levels in use (as published by the DGCA for India Airspace) except that the correlation of levels to track prescribed therein shall not apply whenever otherwise specified in ATC clearance.
19. **Cruising Level of IFR Flights Outside Controlled Airspace.** An IFR flight operating in level cruising flight outside controlled airspace shall be flown at a cruising level appropriate to its track as specified in the cruising levels in the Indian airspace (except when below 3000 ft amsl).
20. **Communication.** An IFR flight operating within specified areas or along specified routes outside controlled airspace shall maintain a listening out watch on the appropriate radio frequency and establish two way communication as necessary, with the ATS units providing flight information service / advisory service.
21. **Position Reports.** An IFR flight operating outside controlled airspace shall comply with the following provisions
 - (a) Submit a flight plan.
 - (b) Maintain listening out watch on the appropriate radio frequency and establish two way communication as necessary with the air traffic service units providing flight information service and shall report position as specified (rules of the Air-General).

RIGHT OF WAY RULE

(Slide 11-14)

22. The following are some of the basic rules laid down to reduce the risk of collision:
- (a) Right of way procedure: aircraft are to give way to each other in the following orders.
 1. Aero planes
 2. Helicopters
 3. Airships
 4. Tug and glider combinations
 5. Gliders
 6. Balloons

For example, aero planes give way to all other types of aircraft.
 - (b) **Converging**: When two aircrafts are on the paths which cross, the aircraft which has the other on its right is to give way.
 - (c) **Approaching head on**: When two aircrafts are approaching head on, each is to alter heading to the right.
 - (d) **Overtaking**: An aircraft overtaking another aircraft is to avoid the overtaking aircraft by altering heading to the right, and is to keep clear until all risk of collision is past. Sub para (a) does not apply to this rule. An aircraft is overtaking another aircraft, when it is approaching from the rear at an angle of less than 70 degree to the fore and aft axis of the overtaken aircraft.
 - (e) **Landing**: Aircraft in the final stage of landing have the right of way over aircraft in the air and on the ground. Sub para (a) does not apply to this rule.
 - (f) **Approaching to land**: The aircraft at the lower altitude on the approach has the right of way; normally, however, as a matter of courtesy, captains of light maneuverable aircraft give way for the heavier types in which the overshoot procedure is involved.
 - (g) **Emergency landing**: An aircraft seen, or known to be carrying out an emergency landing has the right of way over all others. Every aircraft obliged by the above rules to keep out of the way of another, is, if possible, to avoid passing over a under the other or crossing ahead of it. The aircraft having the right of way should normally maintain its heading and speed.

CIRCUIT RULES

(Slide 15)

23. The airfield circuit is the airspace extending to 3,000 ft. above airfield elevation, on a radius of 18,000 ft. from the centre of the airfield. When flying in the circuit, a pilot is to:
- (a) Keep a sharp look out for other aircraft in the vicinity.
 - (b) Conform with or avoid the traffic pattern.

- (c) Maintain a continuous listening watch on the aerodrome R/T frequencies and keep a sharp look out for any visual signals which may be displayed.
- (d) Obtain, by R/T or visual means, authorization for any movements.

MINIMUM ALTITUDES

(Slide 16)

24. Except for taking off and landing, aircraft are not to be flown over built over areas, or assemblies of people, etc. unless at an altitude that would enable them to be landed clear in the event of an emergency landing being necessary. In all cases, their altitude must be such that a minimum height of 2,000 ft. above the ground in maintained.

FLIGHT LEVEL SEPARATION SYSTEM

(Slide 17-18)

25. For most small aircraft flying outside controlled airspace in good weather, the pilots are responsible for maintaining a safe distance from other aircraft. This is the "see and be seen" principle otherwise known as VFR or Visual Flight Rules. In this mode of operation, a pilot must keep a continual watch for other aircraft in the sky.

26. When flying above 3,000 feet above ground level (AGL), the pilot must follow VFR cruising altitudes given below (or east/west cruising altitudes).

Flying a magnetic course of 0° - 179°, fly at odd thousands plus 500 feet. For example, 3,500; 5,500; 7,500.

Flying a magnetic course of 18° - 359°, fly at even thousands plus 500 feet. For example, 4,500; 6,500; 8,500.

27. For aircraft flying inside controlled airspace, pilots are still responsible for maintaining a safe distance from other aircraft. They also must strictly follow IFR or Instrument Flight Rules. In this mode of operation, pilots are flying under reduced visibility and must depend on their instruments for additional guidance and information. Though rules of separation vary depending on the airspace in which a aircraft is flying, in general, air traffic controllers and pilots are required to maintain a horizontal distance of 5 nautical miles between 2 aircraft flying at the same altitude. For altitudes at and below 29,000 feet, vertical separation must be maintained at a minimum 1,000 feet. For altitudes above 29,000 feet vertical separation must be maintained at a minimum of 2,000 feet.

COMPLIANCE WITH THE RULES

28. The captain of an aircraft flying within the Indian union is to comply with rules of the air, standard flying orders, and air traffic control regulations, except when:

- (a) He considers that compliance with them will jeopardize the safety of his aircraft or when circumstances beyond his control compel a violation.
- (b) He is operating under the radar surveillance of a ground controlling authority which is in contact with the A.T.C.C. in whose flight information region the flight is taking place.

(c) He is engaged in an operational flight on exercise for which special arrangements have been made.

The captain of an aircraft using civil aerodrome is to comply with the civil procedures in force at that aerodrome.

CONCLUSION

(Slide 19)

29. Therefore it is mandatory for all the pilots to follow rules and regulations as given in the relevant publications and amended thereof from time to time. In case the captain of an aircraft experiencing circumstances which may lead to an unavoidable violation of A.T.C. regulations he is to inform air traffic control by radio as soon as possible, so that other aircraft may be safeguarded. The message is to be passed by the most direct means to the controlling authority concerned and is to include call sign, aircraft type, position, altitude, heading, airspeed, and relevant details of the violation. Air traffic control is also to be informed as soon as regular observance of the regulations can be resumed.

CIRCUIT PROCEDURES**(AR-4)**

Period	-	IV
Type	-	Lecture
Term	-	I Year
Revised by	-	

Training Aids

1. Computer slides pointer, white board, board marker and duster

Time Plan

2.	(a)	Introduction	- 05 minutes
	(b)	circuit Terms	- 15 minutes
	(c)	circuit Procedure	- 15 minutes
	(d)	Conclusion	- 05 minutes
		Total	40 minutes

INTRODUCTION

Slide 1

1. A pattern for traffic movement has been established for use at all aerodromes. It is called a **traffic circuit** and it expedites and separates airplanes using the same aerodrome. It is the responsibility of every pilot, for safety and efficiency, to learn and follow the proper traffic procedures when coming in to land at an aerodrome.

AIM

Slide 2

2. To teach the cadets about the CCT terminology/definitions ,take off, and landing procedures.

TRAFFIC CIRCUIT PROCEDURE

Slide 3-7

The following definitions apply to portions of the traffic circuit:

3. The **upwind side** is the area on the opposite side of the landing runway from the downwind leg. Approach should be made into this area at or above circuit height.
4. The **circuit joining crosswind** is a corridor, lying within the airspace between the centre of the landing runway and its upwind end, linking the upwind side and the downwind leg.
5. The **downwind leg** is a flight path, opposite to the direction of landing, which is parallel to and at a sufficient distance from the landing runway to permit a standard rate –one turn to the base leg.
6. The **base leg** is a flight path at right angles to the direction of landing and sufficiently downwind of the approach end of the landing run-way to permit at least a $\frac{1}{4}$ mile final approach leg after completion of a standard rate –one turn to final approach.
7. The **final approach leg** is a flight path in the direction of landing, commencing at least $\frac{1}{4}$ mile from the runway threshold, wherein an airplane is in line with the landing runway and descending towards the runway threshold.

THE TRAFFIC CIRCUIT AT CONTROLLED AIRPORTS

8. The traffic circuit at controlled airport is similar to that at an un-controlled airport .It consists of the cross wind leg, a down wind leg, a base leg and a final approach leg .The principal difference is that you must established communication with the control tower if flying at controlled airports.

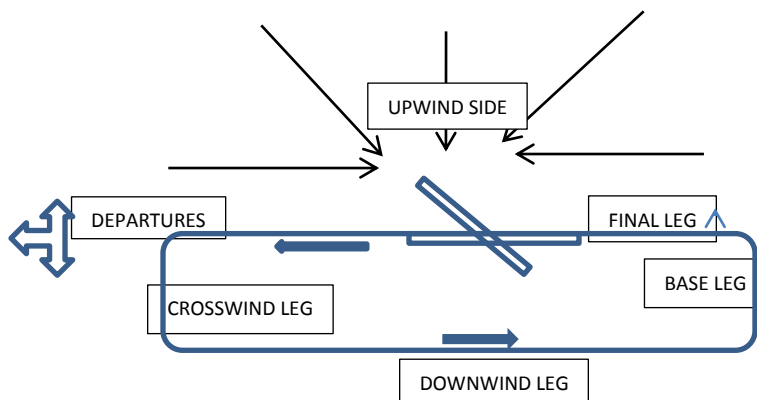

9. You must establish and maintain radio communication with the control tower prior to operating within the control zone served by an operational control tower. You must, therefore, call the control tower on the appropriate frequency prior to entering the control zone, give your identification and position and request landing instructions. It is advisable to make this initial call about 5 minutes prior to entering the zone .If the control zone is class B or class C air space ,the appropriate clearance must be received from the controlling agency prior to entry into the classified airspace.

10. The tower controller will advise the runway in use, wind direction and speed, altimeter setting and any other pertinent information and then will clear you to enter the circuit. **“Cleared to the Circuit”** authorizes you to join the circuit on the downwind leg at circuit height. If, because of your position in relation to the runway in use, it is necessary to proceed crosswind prior to joining the circuit on the downwind leg, do so as indicated in above diagram, approaching the active runway from the upwind side at a point midway between each end of the runway staying clear of the approach and departure paths of the active runway .When joining the circuit, you must conform as closely as possible to the altitude, speed and size of the circuit being flown by other traffic.

11. The airport controller may clear you to a straight in approach and in this instance; you may join the traffic circuit on the final approach leg without having executed any other portion of the circuit.

Once established in the traffic circuit ,you should advise the tower of your position (e.g. **“Foxtrot Romeo Lima Tango is downwind”**).The tower will then give you your landing instructions .For example:

Tower: **Piper Foxtrot Romeo Lima Tango you are number one. Give call on finals**
Or

Tower: **Piper Foxtrot Romeo Lima Tango you are number two.**
Follow Cessna 185 now on base leg.

12. You must have landing clearance prior to landing. Normally, the controller will clear you to land as you turn on to final. If this is does not happen, it is your responsibility as pilot to request landing clearance in sufficient time to accommodate the operating characteristic of your airplane. If you do not receive landing clearance, you must pull up and make another circuit. Even after landing clearance is given, the tower may advise you to pull off and go around again if the situation on the runway becomes unsafe for landing. If, after landing clearance is accepted, the situation is such that you, as pilot, feel that there is a hazard to the safe operation of your flight you should advise ATC of your intentions and go around again. If, for example, the cross wind component is too much for the capabilities of your airplane, you may request another runway that is more into the wind if one exists. Always advise ATC of your intentions.

13. After landing you should clear the runway without delay by continuing forward to the nearest available taxi strip or turn off point. Continue to taxi until you have crossed the taxi position hold line, or until you are at least 200ft from the runway. You must not exit a runway onto another runway unless authorised by ATC to do so. If you have landed beyond the last turn up point, proceed to the end of the runway, turn off and wait for permission to taxi back to an intersection. Do not turn and taxi back against the direction of landing traffic unless instructed to do so by the tower. When clear of the active runway, the tower will advise you to switch to ground control who will give you instructions and authorisation to taxi to the parking areas.

14. At some of the larger controlled airports, more facilities than just the tower are available. Runway and weather information is broadcast on the automatic terminal information service (ATIS). Always listen to the ATIS before contacting the tower and then advise the tower that you have the ATIS information. Extended area of class c airspace surrounds some control zones and it is necessary to contact the area control before contacting the tower. Always check the VTA chart if applicable for special procedures that are in force at any airport at which you intend to land.

15. If you are intending to take off from a controlled airport, you must contact ground control for taxi instructions before starting up towards the active runway. At some of the larger airports, you must contact clearance delivery even before contacting ground control to advise of your intentions. Ground control will give you instructions on how to proceed to the active runway and will then advise you to switch to the tower frequency for take-off instructions. When cleared for take-off, you shall acknowledge and take off without delay. Once airborne, remain turned to the tower frequency during the time you are operating within the control zone and preferably until you are at least ten miles outside it. You do not require permission to change from the tower frequency, once you are clear of the control zone and should not request release or report clear when there is considerable frequency congestion.

CONCLUSION

Slide 8

16. The standard circuit begins with a roll down the runway until the aircraft rotates, a climb out to traffic pattern altitude, a right or left climbing turn depending on making either right hand or left hand circuits to 500 feet above ground level perpendicular to the runway, continuing gaining altitude up to 700 feet AGL(as per ac manual), followed by another right or left turn for a downwind leg parallel to the runway, maintaining 700 feet AGL. During the downwind leg the pilot completes pre-landing checks and contacts the control tower advising a full stop landing or a touch-and-go. After seeing the threshold of the runway at 45 degrees behind him/her, the pilot makes another left or right turn descending to 500 feet AGL. The pilot then turns on the last leg, the final approach where clearance to land or for a touch-and-go is expected.

ATC RT PROCEDURE
(AR-5)

Period	-	III
Type	-	Lecture
Term	-	I Year
Revised by	-	

Training Aids

1. Computer slides pointer, white board, board marker and duster

Time Plan

2. (a)	Introduction	- 05 minute
(b)	Definitions	- 10 minute
(c)	Functions	- 15 minute
(d)	Pronunciations	-06 minute
(e)	Conclusion	- 04 minute
	Total	40 Minute

INTRODUCTION:

(Slide 1)

1. As a Air Wing NCC cadet it is must to know about ATC &RT procedure prior to start flying. Timely information of weather, wind speed, position are the essential parameters for flying. To access all the timely required information for a safe operation we must know the ATC & RT procedure.

AIM:

(Slide 2)

2. To acquaint the cadets about the ATS definitions, functions, procedure and standard phraseologies used while communication between aircraft and the ground staff.

DEFINITIONS

(Slide 3-7)

3. **Air Traffic Services.** Services provided for the safe and efficient conduct of flight are termed as air traffic services.
4. **Objectives of Air Traffic Services.**
 - (a) To prevent collision between aircraft.
 - (b) To prevent collision between aircraft on the manoeuvring area and obstructions on that area.
 - (c) To expedite and maintain an orderly flow of traffic.
 - (d) To provide advice and information useful for the safe and efficient conduct of flights.
 - (e) To notify appropriate organisations regarding aircraft in need of search and rescue aid and assist such organisation as required.
5. **The ATS include the following:**
 - (a) Air Traffic Control Services:
 - (i) Area Control Service.
 - (ii) Approach Control Service.
 - (iii) Aerodrome Control Service.
 - (b) Flight Information Service.
 - (c) Air Traffic Advisory Service.
 - (d) Alerting Service.
6. **Air Traffic Control Service.** A service provided for the purpose of:
 - (a) Preventing collisions between aircraft.
 - (b) Prevent collisions on the manoeuvring area between aircraft and obstructions.
 - (c) Expediting and maintaining an orderly flow of air traffic.
7. **Area Control Service.** ATS service for controlled flights in control areas.
8. **Approach Control Service.** ATC service for arriving or departing controlled flights.
9. **Aerodrome Control Service.** ATC service for aerodrome traffic.
10. **Flight Information Service (FIS).** A service provided for the purpose of giving advice and information useful for the safe and efficient conduct of flights. Flight information service shall include the provision of pertinent information such as: Sigmets information, Nav aids, aerodromes facilities, weather etc.

11. **Air Traffic Advisory Service.** A service provided within advisory airspace to ensure separation, in so far as possible, between aircraft which are operating in IFR flight plans.
12. **Alerting Service.** Provided to notify appropriate organisations regarding aircraft in need of search and rescue and assist such organisations when required.
13. **Air Traffic Service Units.**
 - (a) **Area Control Centre.** A unit established to provide air traffic control service to controlled flights, in control areas, under its jurisdiction.
 - (b) **Approach Control Office.** A unit established to provide air traffic control service to controlled flights arriving at or departing from, one or more aerodromes.
 - (c) **Aerodrome Control Tower.** A unit established to provide air traffic control service to aerodrome traffic.
 - (d) **Flight Information Centre.** A unit established to provide flight information service.
14. **Jurisdiction of Various ATS Units.**
 - (a) **Control Area.** An airspace of defined dimensions extending upwards from specified limit above the earth, within which control service is provided to controlled flights.
 - (b) **Control Zone.** An airspace of defined dimensions extending upwards from the surface of the earth to a specified upper limit, within which Air Traffic Control Service is provided to controlled flights.
 - (c) **Aerodrome Traffic Zone.** Airspace of defined dimensions established around an aerodrome for the protection of aerodrome traffic.
 - (d) **Flight Information Region.** Airspace of defined dimensions within which flight information service and alerting service are provided.
 - (e) **Advisory Airspace.**
 - (i) **Advisory area.** A designated area within a flight information region where air traffic advisory service is available.
 - (ii) **Advisory route.** A route within a flight information region along which air traffic advisory service is available.

15. **Responsibilities of the Various A.T.S. Units.** In India the responsibilities of the Area Control Centres are:-

- (a) Providing flight information service to aircraft in flights within its region.
- (b) Providing Air Traffic Control Service to controlled flights within control areas under its jurisdictions.
- (c) Maintaining up-to-date aeronautical information regarding aerodromes and facilities within its region.
- (d) Obtaining current weather information.
- (e) Handling and assisting diversions of aircraft within its region.
- (f) Initiating search and rescue.

16. **Aerodrome Control Tower.** It is responsible for:

- (a) Control of all traffic (aircraft vehicular and pedestrian) on the manoeuvring area of the aerodrome.
- (b) Control of aircraft flying in the vicinity of the aerodrome in VMC.

17. **Approach Control.** It is the provision of air traffic control service for the parts of the controlled flights associated with arrivals or departures.

18. **Area Control** The organisation responsible to provide ATC service to controlled flights in control area is known as "Area Control Centre" Control areas include airways and TMAs (Terminal Manoeuvring Areas).

19. **Functions of Area Control.**

- (a) Issuance of ATC clearance for the purpose of preventing collisions between controlled flights under its control and jurisdiction.
- (b) To expedite and maintain an orderly flow of traffic of flights provided with area control service.
- (c) To provide flight information service.
- (d) To provide air traffic advisory service, if required, in advisory area and routes after proper co-ordination with the concerned FIC.
- (e) Alerting service.

Airways Control

(Slide 11-15)

20. Area Control Service provided to controlled flight in their en-route phase is termed as airways control. To extend area control to en-route traffic, controlled airspace in the form of 'Corridors' are established and defined with radio navigational aids. Such Corridors are known as Airways' and have specified lower and upper limits. An airways extends along a track starting from one navigational aid to another or through series of navigational aids. The width or lateral dimension of airways vary from 8 km to 20 km (4 nm to 10 nm) on either side of the track. An airway is 10 nm wide over land and 20 nm

wide over sea / oceans. This width depends on the accuracies of the navigational aids available along the route.

TMA

21. When different airways approach in the vicinity of one more major aerodromes, the resultant terminal airspace is protected and control area is established. Such controlled areas at the confluence of airways are called “Terminal Manoeuvring Areas” (TMA). TMAs are suitably lined with control zones of the aerodromes, located in terminal airspace to facilitate the provision of approach control service for flights arriving at and departing from these aerodromes.

Transfer of Control

23. Transfer of control from one ATCC / ACC to another takes place:

- (a) At an agreed airways reporting point.
- (b) At the estimated time given for FIR boundary
- (c) At any other agreed D/R position / location.

24. An ATCC transferring control of an aircraft should pass an estimate for the arrival of such aircraft at the transfer point to the next ATCC / ACC 30 minutes ahead of aircraft's actual passage and on subsequent revision to this estimate in excess of 3 minutes.

25. If 30 minutes prior intimation cannot be given an 'approach acceptance' request shall be made to the ATCC / ACC accepting/taking over control of aircraft.

26. Instruction regarding the transfer of communication will normally be given to aircraft 5 minutes before the ETA over transfer point.

RT PROCEDURES AND PHRASEOLOGY

28. Radio Communication Standard Phraseologies.

(Slide 16-18)

1. <u>Spelling Alphabets.</u> When proper names, service abbreviations and words of which the spelling is doubtful are spelled out in Radio Telephony (RT) the following alphabet shall be used: Letter to be Identified	Identifying Word	Representation of Pronunciation in English
A	Alfa	Alphah
B	Bravo	BrahVoh
C	Charlie	Charlee (or Shar Lee)
D	Delta	Dell Tah
E	Echo	Eck Oh
F	Foxtrot	Foks Trot
G	Golf	Golf
H	Hotel	Hoh tell
I	India	In Dee Ah
J	Juliet	Jew Lee Et
K	Kilo	Key Loh
L	Lima	Lee Mah
M	Mike	Mike
N	November	No Vem Bar
O	Oscar	Oss Car
P	Papa	PahPah
Q	Quebec	Qeh Beck
R	Romeo	Row Me Oh
S	Sierra	See Airrah
T	Tango	Tang Go
U	Uniform	You Nee Form
V	Victor	VikTah
W	Whiskey	Wiss Key
X	X-Ray	Ecks Ray
Y	Yankee	Yan Key
Z	Zulu	Zoo Loo

2. <u>Pronunciation of Numbers.</u>		
1	One	Wun
2	Two	Too
3	Three	Tree
4	Four	Fower
5	Five	Fife
6	Six	Six
7	Seven	Saveen
8	Eight	Ait
9	Nine	Niner
0	Zero	Zee Row
.	Decimal	Day - See - Mal
1000	Thousand	Tou - sond
<p>3. All numbers except whole thousand will be transmitted by pronouncing each number separately. Whole thousands shall be transmitted by pronouncing each digit in the number of thousand followed by the word thousand. Some of the examples are</p>		
Number		Spoken As
10		One Zero
75		Seven Five
100		One Zero Zero
583		Five Eight Three
5000		Five Thousand
25000		Two Five Thousand

CONCLUSION

(Slide-19)

51. Standard phraseology is recommended in the interest of clarity and brevity. The use of standard phrases does provide uniformity in transmission and makes your transmission more readily understood by ground station operator and vice versa. Correct procedure on the part of operators of radio telephony equipment is necessary for the efficient exchange of communication and is particularly important where lives and property are at stake. It is also essential for a sharing of "on the air" time in the crowded radio spectrum.

AVIATION MEDICINE**(AR-6)**

Period	-	VI
Type	-	Lecture
Term	-	I Year
Revised by	-	

Training Aids

1. Computer slides, pointer, white board, board marker and duster

Time Plan

2.	(a)	Introduction	- 05 minute
	(b)	Fitness	- 05 minute
	(c)	Oxygen Requirement	- 10 minute
	(d)	Flying Fatigue	-05 minute
	(e)	Effects on ear	- 05 minute
	(f)	Decompression sickness	- 10 minute
		Total	40 Minute

(Slide 1)

INTRODUCTION

1 Since flying an airplane demands that the pilot be alert and in full command of his abilities and reasoning, it is only common sense to expect that an individual will ensure that he is free of any conditions that would be detrimental to his alertness, his abilities to make correct decisions, and his rapid reaction times before sitting himself behind the wheel of an airplane. Certain physical conditions such as serious heart troubles, epilepsy, uncontrolled diabetes and other medical problems that might cause sudden incapacitations and serious forms of psychiatric illness associated with loss of insight or contact with reality may preclude an individual from being judged medically fit to apply for a license. Other problems such as acute infections are temporarily disqualifying and will not affect the status of a pilot's license. But they will affect his immediate abilities to

fly and he should seek his doctor's advice before returning to the cockpit of his airplane.

In fact, any general discomfort, whether due to cold, indigestion, nausea, worry, lack of sleep or any other bodily weakness, is not conducive to safe flying. Excessive fatigue is perhaps the most insidious of these conditions, resulting in inattentiveness, slow reactions and confused mental processes. Excessive fatigue should be considered a reason for cancelling or postponing a flight.

Slide2

AIM

2. To teach the Cadets about aeromedical aspects in aviation, lack of oxygen effects/hypoxia, fatigue and decompression sickness.

(Slide3-10)

HYPOXIA

3. The advance in aeronautical engineering in recent years has produced more versatile airplanes capable of flying at very high altitudes. At such high altitudes, man is susceptible to one of the most insidious physiological problems. **Hypoxia** comes on without warning of any kind, supplementary oxygen must be available in any aircraft that will be flown above 10,000 Feet. The general rule of oxygen above 10000 ASL by day and above 5000 ASL by night is one the wise pilot will practice to avoid hazard of these deliberating conditions. Hypoxia can be defined as a lack of sufficient oxygen in the body cells or tissues.

4. The greatest concentration of air molecules is near to earth's surface. There is progressively less air and therefore less oxygen (per unit volume) as you ascend to higher altitudes. Therefore each breath of air that you breath at, for example, 15000 feet ASL has about half the amount of oxygen of a breath taken at sea level.

5. The most important fact to remember about Hypoxia is that the individual is unaware that he is exhibiting symptoms of this condition. The brain centre that would warn him of decreasing efficiency is the first to be affected and the pilot enjoys a misguided sense of well-being. Neither is there any pain nor any other warning signs that tell him that his alertness is deteriorating. The effects of Hypoxia progress from euphoria (feeling of well-being) to reduced vision, confusions, inability to concentrate, impaired judgment, and slowed reflexes to eventual loss of consciousness.

.Effects on vision at 5000 Feet.

6. The retina of the eye is actually an outcropping of the brain and as such is more dependent on an adequate supply of oxygen than any other part of the body. For this reason, the first evidence of hypoxia occurs at 5000feet in the form of diminished night

vision. Instruments and maps are miss read, dimly lit ground features are misinterpreted.

Above 10000 Feet

7. It is true that general physical fitness has some bearing on the exact altitude at which the effects of Hypoxia will first effect a particular individual. Age, drinking habits, use of drugs, lack of rest, etc, all the increase the susceptibility of the body to these conditions. However, the average has been determined at 10000 feet.

8. At 10000 feet, there is a definite but undetectable Hypoxia. This altitude is the highest level at which a pilot should consider himself efficient in judgment and ability. However, conditions operation even at this altitudes for periods of more than , say 4 hours can produce fatigue because of the reduced oxygen supply and a pilot should expect deterioration in concentration, problem solving and efficiency.

9. At 14000 feet, lassitude and indifference are appreciable. There is dimming of vision, tremor of hands, clouding of thought and memory and errors in judgment. Cyanosis (blue discoloring of the finger nails) is first noticed.

10. At 16000 feet, a pilot becomes disoriented, is belligerent euphoric and completely lacking in rational judgment. Control of the airplane can be easily lost.

11. At 18000 feet, primary shocks set in and the individual loses consciousness within minutes. At higher altitudes, death may result after a prolonged period.

Prevention of Hypoxic Hypoxia

12. The only way to prevent Hypoxia is to take steps against it before its onset. Remember the rule: Oxygen above 10000 feet by day and above 5000 feet at night.

HYPERVENTILATION

(Slide 11-13)

13. Hyperventilation, or over breathing, is an increase in respiration that upsets the natural balance of oxygen and carbon dioxide in the system, usually as a result of emotional tension or anxiety. Under conditions of emotional stress, fright or pain, a person may unconsciously increase his rate of breathing, thus expelling more carbon dioxide than is being produced by muscular activity. The result is a deficiency of carbon dioxide in the blood.

14. The most common symptoms are dizziness, tingling of the toes and fingers, hot and cold sensations nausea and sleepiness. Unconsciousness may result is the breathing rate is not regulated.

15. The remedy of hyperventilation is a conscious effort to slow down the rate of breathing and to hold the breath intermittently to allow the carbon dioxide to build up to a normal level. Some time, the proper balance of carbon dioxide can be more quickly restored by breathing into a paper bag, that is, by re-breathing the expelled carbon dioxide.

16. The easily symptoms of hyperventilation and Hypoxia are similar and may be confused. In fact, both conditions can occur at the same time. A pilot, flying at high altitude, may think that he can counteract the effects of Hypoxia by taking more rapid breaths. Hyperventilation does not help you get more oxygen. It only increases the emissions of carbon dioxide. Hypoxia is unlikely to occur below 18000 feet ASL. Above 18000 feet, if oxygen is available, take 3 or 4 deep breath of 100% oxygen. If the symptoms persist, the problem is hyperventilation and should be treated as such.

DECOMPRESSION SICKNESS

(Slide 14-17)

Trapped Gases

17. Because of the change in barometric pressure during ascent and the descent, gases trapped in certain body cavities expand or contract. The inability to pass these gas may cause abdominal pain, toothache or pain in ears or sinuses cavities. In some cases, the pain may be so severe as to lead to incapacitation. The conditions caused by changing barometric pressure are known as **Dysbarisms**: any physical damage that results is called a **Barotraumas**.

EAR BLOCK

18. The ear is composed of three sections. The outer ear is the auditory canal and ends at the eardrum. The middle ear is a cavity surrounded by bones of the skull. It houses the organs of hearing and is filled with air. The Eustachian tube connects the middle ear to the throat. The inner ear controls certain equilibrium senses and contains the cochlea, a small organ that analyses sound vibrations.

19. During ascent and descent, air must escape or be replenished through the Eustachian tube to equalize the pressure in the middle ear cavity with that of the atmosphere. If air is trapped in the middle ear, the eardrum stretches to absorb the higher pressure. The result is pain and some time temporary deafness. Eardrum rupture is even possible.

20 During climbs, there is little problem since excess air escapes through the tube easily. However, during Descends, when pressure in the middle ear must be increased, the Eustachian tubes do not open readily. The situation is aggravated if the individual has a cold, and allergy or an infected throat. Pilot and passengers must consciously

make an effort to swallow or yawn to stimulate the muscular action of the tubes. Some times it is advisable to use the **Valsava technique**, that is, to close the mouth, hold the nose and blow gently.

FLYING FATIGUE

(Slide 17-21)

22. Fatigue is one of the most common psychological problems for air crew members and will adversely affect individuals who are otherwise in good health. It has repeatedly been cited as the casual factor in air plane accident. Fatigue degrades performance. A tired pilot cannot carry out task as reliably and accurately as he should. He is irritable and less alert, willing to accept lower standards of accuracy and performance. Fatigue begins when the pilot begins a flight and increases with each hour in the air. As a result, at the time of landing when reflexes and judgment should be keenest, the pilot is most affected by the cumulative effects of fatigue. The biggest danger of fatigue is that an individual may not recognize its effects. The onset of fatigue is accompanied by numerous symptoms: deterioration in timing of movements, irritability and lack of patience, a tendency to lock the attention on individual instruments rather than to see the instrument panel as a whole, a tendency to become forgetful and ignorant of relevant cues, a tendency to over control the air plane, and awareness of physical discomforts, a loss of "sear of the pants" flying ability, a tendency to accept a wider margin of error than normal.

Fatigue is caused by many things: lack of sleep, poor nutrition, stretch, prolonged and repeated flights, air craft noise, eye strain, vibration, wide vibrations in temperature and humidity, heavy work load and uncomfortable working conditions, boredom, monotony, night flights, frustration from work and family.

Acute fatigue is easily treated by a meal and a good sleep. Chronical fatigue is more serious and is caused by difficult or stressful work with inadequate rest and is often aggravated disturbed circadian rhythms.

A sound physical condition, a healthy mental attitude, proper diet and adequate rest are a pilots best weapons in fighting fatigue. On very long flights where the pilot and co-pilot share the piloting duties, the advantage of taking a 15-20 minutes pre planned power nap shows beneficial results in improved performance. Conversation and discussion help to keep us awake. Caffeine in moderation helps. Frequent small meals to keep up the blood sugar relieve fatigue.

CONCLUSION

The purpose of this lecture has been to make the aviators aware of the aeromedical aspects of aviation ,importance of oxygen content in the body /Hypoxia, hyperventilation ,flying fatigue etc. The most competent, knowledgeable and experienced pilot continue to fly as long as he is medically fit. Maintaining physical fitness is therefore of prime importance.

The person who is physically active, participating in a regular routine of exercise or sports, will most likely have a healthy heart, lungs and not be overweight. Diet is important not only to keep weight at an acceptable level, but also in the control of heart disease. The case against smoking as a contributor to lungs disease and heart disease is heavily documented. Protection of hearing by wearing earplugs has already been mentioned as has the need to protect the eyes from undue eyestrain.

SURVIVAL
(AR-7)

Period	-	VII
Type	-	Lecture
Term	-	I year
Revised by	-	

Training Aids

Computer slides, pointer, white board, Marker and duster.

Time Plan

a) Introduction	- 05 Min
b) Pattern of Survival:	- 05 Min
c) Chances of survival	- 05 Min
d) Stages of Survival	- 10 Min
e) Plan of Action	- 10 Min
f) Conclusion	- 05 Min

Total	- 40 Min

INTRODUCTION:

(Slide 01)

1. The instinct to survive is a law of nature and when forced with a hostile environment, survival mainly depends on two factors:-

- (a) The ingenuity of the individual.
- (b) Resources available.

2. With proper knowledge, good training and reasonable equipment, it will be possible to achieve this objective. The time to study survival techniques is not after abandoning the aircraft but before.

3. The important aids to survival are:

- (a) Will to survive.
- (b) Prior knowledge of terrain.
- (c) Preparedness in use of available aids and improvisation.

(d) Available equipment, food, water and confidence in available aids.

AIM

(Slide 02)

To teach cadets about the General and Land survival aspects in aviation

PATTERN OF SURVIVAL

(Slide 03)

4. The pattern of survival depends upon:
- (a) Pre Flight plan.
 - (b) Protection from animals, enemies, environment.
 - (c) Location of aids.
 - (d) Water, food and health hazards.

CHANCES OF SURVIVAL

(Slide 04-08)

Factors Promoting Chances of Survival:

5. (a) Common sense.
 (b) Determination and will to survive.
 (c) Courage.
 (d) Training
 (e) Equipment.
 (f) Luck.

Factors Reducing Chances of Survival :

6. (a) **Psychological.** Panic, fear, loneliness, boredom fear of unknown, darkness and jungle animals.
 (b) **Physiological.** Heat / Cold, injuries, illness, shortage of food and water

STAGES IN SURVIVAL

(Slide 09-13)

7. (a) **Pre-Flight.** Proper knowledge and training about terrain and equipment, good physical fitness and reasonability of equipments provided, are all extremely important preparations for survival. Practical survival training earned during survival exercises, which are conducted periodically is very helpful.
 (b) **In Flight.** Communicate to the base about emergency, location and decision to abandon aircraft. During descent with the aircraft or by parachute observe all ground features, as far as possible.

(c) **Post Flight.** Immediately clear off the aircraft to safer distance to avoid hazard of fire and explosion. Attend to injuries if any. Rest, cool down and assess the situation. Contact base, if possible, by aircraft radio set or use distress signal radio set, if available. Plan and decide the course of action depending on available shelter, food and water. Decide whether to stay near or leave the aircraft. Always choose to remain with the aircraft unless:

- (i) Shelter and assistance are within easy range and can be reached with the equipment and rations available.
- (ii) In enemy territory.
- (iii) If after several days it is apparent that rescue has failed or is not forthcoming. Even in this case all possible precautions should be taken for travelling.

(d) **Subsequent Action.** Signalling so as to indicate your own location and help rescue team in locating the survivors. This is done by using mini flare or radio sets provided with the survival pack. Signalling can also be done by smoke, fire, pyrotechnique or heliograph. Do everything and anything to disturb the natural look of surroundings to catch the attention of rescue team

LAND SURVIVAL

(Slide14-20)

Jungle Survival

10. "Jungle" is a term applied to natural forest of a particular land or region. It may be wet tropical rain forest or dry open scrub country. Whatever the type of country, the chances of survival after a successful landing depend on a number of factors, viz:

- (a) Previous knowledge.
- (b) Previous attention to personal clothing and kit.
- (c) Strict observance of a few simple rules.
- (d) Initiative.
- (e) Discipline.
- (f) Frequent Practices.
- (g) Ability to learn by mistakes.

11. **Entering Jungle.** Prior to entering the jungle, whether by bailing out or by crash landing, a mental note of the topography should be made. This should include features like rivers, lakes, paddy fields, high ground, villages etc. The heading and bearing of the aircraft and the position of the aircrew members, who may have bailed out, will help orientation on the ground and location of crew members.

12. **On Landing.** A set drill should be adhered to. This should include:

(a) First Aid is important and especially in tropical countries where wounds become septic very quickly. Therefore, learn how to use the few simple remedies provided in first aid kits.

(b) Orientate yourself as regards position and time.

(c) Prepare emergency signalling gear remembering that depending on the terrain, the ground may have to be cleared to enable ground signals to be seen from the air. These signals may include the use of cloth strips (parachute canopy is use full), fire, smoke, and the use of pyrotechnics provided in the survival pack.

(d) Check the equipment and rations that may be available and calculate the estimated requirements, remembering that this can be supplemented by the jungle.

Plan of Action

13. Decide on a plan of action whether to remain with the aircraft or to trek factors which would help in coming to a decision are as follows:

(a) Is base aware of the exact position and predicament?

(b) What are the chances of air / surface search?

(c) Will the weather be favourable for air search?

(d) Is the area in the vicinity of a recognized air route?

(e) Distance from human habitation.

(f) Time of the year.

(g) Type of country.

(h) Hazards of trek.

(j) Condition of personnel and equipment.

14. Whatever decisions is made, act without delay but not in haste. If remaining with the aircraft attract attention. In addition to the emergency signalling gear, the fullest use should be made of parachutes, dinghies, engine cowlings and broken glass as reflecting surfaces. Ground signals to be effective should be 8' in length. If trekking, select only those items of equipment which are absolutely essential to survival- do not carry too much use full items are parachute packs from which shoes can be improvised, shroud lines of parachutes which will be useful as fishing tackle, first aid kit, personal pack and a hatchet / knife. A compass, maps, matches/ lighter, mirror for signalling, pencil and note book will also be useful should you decide to take extra clothing, socks should be given a priority.

15. **The Trek.** The technique for trekking is to conserve energy and therefore to proceed slowly and deliberately follow streams "down stream" as they will lead to habitation don't try any short cuts. Use game trails, dry water courses, ridges and other high ground if available. While trekking always lay a trail by marking trees, felling branches with yours jungle knife etc. Avoid swampy ground.

16. **Camping.** When camping chooses a site close to sources of water, food and solid ground, taking whatever natural protection is available from the weather. Avoid areas where there is dead and decaying vegetation. Prepare the site and light a fire as soon as possible, both to drive away insects and also for cooking. When the fire has produced a certain amount of ash, spread it in an unbroken line round the camp site to prevent the intrusion of crawling insects. Lighting a fire is not as simple as Survival. It would appear, and this becomes even more difficult when improvised methods are used. It would pay aircrew to practice the several methods of lighting a fire, e.g. by user of sun glass drill method, flint and steel etc.

17. **Water.** All water should be purified, using the water sterilizing tables provided or boiling for at least three minutes. There are some sources of water which do not require purification:

- (a) Rain
- b) Jungle vines- the lower loop of any vine will provide water.

18. **Food.** This is seldom a problem in the jungle. It is important to know types of edible fruits available in the particular area in which you operate. The food eaten by monkey can be considered as generally fit for human consumption. The chief sources of food are normally plant, fish and birds. Animal are potential source of food but are not always easy o catch and kill.

19. **Jungle Hazards.** Most stories about animals, snakes and other terrors of the jungle are not based on fact you are safe from sudden death in a jungle than you are in a city. The real dangers are:

(a) **Panic.** This is by far the greatest hazards. Remember that the obstacles you have to overcome are not so much natural ones as mental ones. Other people have lived in such areas intentionally and by adjustments to the demands of terrain, climate and environment. You too can survive.

(b) **Sun and Heat.** This may take the form of heat exhaustion or heat stroke. The former is characterized by vomiting, and cramps and a feeling of faints, and later by high temperature, dry skin and may be unconsciousness. Keep yourself under shade and consume enough cold water.

(c) **Dysentery.** This is an inflammation of the bowel characterized by pain in the abdomen and the passage of frequent loose stools with possibly blood. Prevention is by cooking your food and purifying. If dysentery is suspected solid food could be avoided. Large quantities of water should be taken to replace lost body fluids.

(d) **Animals Leaches.** Leaches attach themselves to human body and should be removed either by touching with salt or tobacco or burning with the lighted end of a cigarette. They should not pull off as they leave their jaws in the bite which will cause a festering sore.

(e) **Ticks.** These infect clothing and can be flicked off the skin. Be careful in this case also as the head may stay in the skin and start infection. Use an antiseptic on the bitten area.

(f) **Snakes.** These seldom attack man unless provoked. In case of snake bite do not run about. Tie a tourniquet above the wound. Loosen the tourniquet every 10 – 15 minutes for 2- 3 minutes. Squeeze out the blood from the wound and wash with water.

(g) **Wild Animals.** Wild animals seldom interfere with man. While travelling through animal infested country, make as much noise as possible. This will scare away big game. At night keep a fire burning and a member of the party on watch. Bamboo thrown on a fire will burn with a loud noise resemble gun shots sufficient to drive away animals.

20. **Personal Hygiene.** This most important and the following points must be borne in mind:

(a) **Care Of Feet.** Wash socks each day, wash your feet thoroughly, keep your foot wear dry by keeping hear the fire at night.

(b) **Sanitary Arrangements.** Keep all sanitary arrangements clear of the shelter or camp. Keep all waste matter covered with a layer of earth to prevent fly breeding.

(c) **Blisters.** These should be treated immediately. The edge may be pricked by a sterilized needle and the fluid pressed out. It should then be kept clean and dry.

SEA SURVIVAL

(Slide 21-30)

21. Stay clear of airplane but in vicinity until it sinks. Search for missing men. Salvage floating equipment and stow all items securely. Plug leaks in raft and bail it out. Check condition of crew; give first aid if necessary. The sickness pills, if available. Get emergency radio into operation. Directions are on equipment. Prepare other signalling devices for instant use. Keep compass, watches, matches and lighters dry. Place in water proof containers. If there is more than one raft, connect them with at least 25 feet of line. Check raft for inflation and leaks and point of possible chafing. Be careful not to snag raft with shoes or sharp objects.

22. **In Cold Water.** If near shore, get ashore at once or try to minimize exposure to cold water. Huddle together and exercise regularly.

23. **In Warm Ocean.** Rig sun shade Keep skin covered. Use sunburn cream. Keep sleeves rolled down and socks pinned up or pulled up over trousers. Wear hat and sun glasses. Make use of parachute to cover the raft to avoid exposure to the sun heat.

24. Make a calm estimate of your situation and plan course of action carefully.
25. **Keep a log.** Record navigator's last fix, time of ditching, names and condition of personnel, ration schedule, winds, weather, direction of swells and other navigation data. Inventory all equipment. Keep calm. Conserve water and food by conserving energy. Don't move around unnecessarily-life rafts capsize easily.

26. **Health Hazards**

- (a) **Sea Sickness.** Use airsickness or seasickness tablets as early as possible and repeat at every 6-8 hrs. Do not eat or drink while sea sick.
- (b) **Salt Water Sores.** Apply antiseptic cream, do not squeeze them.
- (c) **Immersion Foot.** Individual complaints of burning, itching, mottling or redness tingling, numbness and blister may develop. This is due to exposure of feet to cold. Keep the feet dry, maintain circulation by exercising toes and keeping feet warm.
- (d) **Sore Eyes.** Glare from sky and sea water causes itching watering and irritation of eyes. Can be easily prevented by using goggles, visors or antiglare sheets provided.

TYPES OF SURVIVAL KITS

27. The survival packs are basically two types- Fighter Type and Transport / Helicopter type. The contents of most of the survival packs are, a first aid kit, water, food, signalling & location aids, some safety equipment, extra clothing like socks, antiglare goggles and a booklet on survival.

28. The specific items in different types of survival packs are as follows:
- (a) Desert Type - Extra water bottles.
- (b) Snow Type - A sleeping bag.
- (c) Sea Type - One man dinghy in Fighter type & multi-men dinghy in Transport / Helicopter along with its accessories. These accessories are:
- (i) Fluorescent dye for identification and as shark repellent.
- (ii) Chemical Desalination Kit for making sea water drinkable.

29. **Points to Remember**

- (a) You have every chance to come out safely. Keep cool, don't get panicky. Save your energy. Don't rush off wildly, Stop think out & size up your situation. Plan a sensible course of action and keep up your morale.
- (b) Remember Help is on the way.
- (c) Avoid hardship and stay well. Find food and water. Obtain help and out safely.
- (d) Every survival pack has a booklet for guidance. Read it as soon as possible.

CONCLUSION

30. Experience has shown that personnel equipped and trained in sound survival technique will have substantially a better chance of evading capture and making good their escape to friendly control. During the initial stages when the individual is isolated, knowledge of correct survival techniques very often means, the difference between remaining alive and free or submission to capture in order to obtain shelter, food and medical care. If he is forced to travel to areas more suitable for extended survival or to rendezvous points in friendly control, knowledge of how to survive while on the move will be essential. If the distance to friendly territory is such that isolated personnel must practice extended static survival in difficult terrain and adverse weather conditions, knowledge of correct survival techniques will again be essential for success.

CHAPTER – VII
NAVIGATION

NAVIGATION – REQUIREMENTS OF NAV**(NV-1)**

Period - I
 Type - Lec
 Year - II
 Revised by -

Trg Aids

1. Computer slides, pointer, black bd and chalk.

Time Plan

2.	(a)	Intro	-	05 mts
	(b)	Requirements of Nav	-	15 mts
	(c)	Imp in Aviation	-	15 mts
	(d)	Conclusion	-	05 mts
		Total		----- 40 mts -----

INTRO

(Slide 1)

3. Air Navigation is the art of guiding an aircraft through the air, so that it arrives at a desired position at a pre-calculated time. Air Navigation differs from surface navigation in several ways such as the aircraft travels at relatively high speeds, leaving less time to calculate their position enroute. Aircraft also normally cannot stop in mid-air to ascertain their position at will.

AIM

(Slide 2)

4. To teach the cadets about the requirement of Navigation and its importance in aviation.

PREVIEW

(Slide 3)

5. The lecture will be conducted in the following parts:-
- (a) Part-I : Requirement of Navigation.
 - (b) Part-II : Importance of Air Nav in aviation.

REQUIREMENTS OF NAVIGATION

(Slide 4-6)

6. A number of times Pilot may be called upon to navigate the aircraft himself especially in the aircraft types where no navigation is provided or in a single seat aircraft, hence a thorough knowledge of the art of navigation is a must for a pilot.
7. Since the pilot has the primary duty of flying the aircraft, it would not be possible for him to carry out the detailed task of a professional navigator in usage of plotting tables, computers, charts etc. He however has to be skilled in map reading and mental DR in order to navigate accurately.
8. Techniques used for air navigation in the air can be broadly classified into two groups.
- (a) Visual Flight Rules (VFR):- The pilot largely navigates using dead reckoning combined with Visual observations with reference to appropriate maps. This may be supplemented by radio navigation aids.
 - (b) Instrument Flight Rules (IFR):- Under these rules the pilot will navigate exclusively using instruments and radio nav aids such as beacons, or as directed under radar control by a controlling air traffic controller.
9. Before the flight the pilot must take pains to prepare and plan the flight meticulously. For planning he will have to refer to the correct scale of maps, take forecast winds into consideration, plan the cruising altitude, calculate ground speed and time of flight and quantity of fuel required. He also would require to study the various nav aids available at the departure, alternate and destination aerodromes, enroute check points, their frequencies, time of availability etc.
10. Once in flight the pilot must stick to the plan otherwise getting lost is all too easy. This is especially true if flying over featureless terrain or flying in the dark. This means that the pilot must stick to the calculated headings, heights and speeds as accurately as possible.

IMPORTANCE IN AVIATION

(Slide 7-8)

11. Apart from map reading and mental DR (mental dead – reckoning) the pilot navigator should also be able to fly the aircraft accurately. Variation in speed, heights and directions often results in unexpected gross errors and place the aircraft quite far away from the desired track and time. A good pilot will plan a good flight meticulously and fly that good plan.

12. Successful air navigation involves piloting an aircraft from place to place without getting lost, breaking the laws applying to aircraft or endangering the safety of those on board or on ground.

CONCLUSION

(Slide 9)

13. Air Navigation is an important aspect of aviation and learning the skills involved in good navigation techniques is an important aspect of flight training. Once these techniques are learned on ground, they must be put to practice to gain experience in pilot navigation technique as sorties from day to day will differ depending on conditions, situations and environment.

GLOSSARY OF TERMS**(NV-2)**

Period	-	II
Type	-	Lecture
Year	-	II
Revised by	-	

Trg Aids

1. Computer slides, pointer, black board and chalk.

Time Plan

2.	(a)	Intro	-	05 mts
	(b)	Definitions	-	30 mts
	(c)	Conclusion	-	05 mts
		Total		----- 40 mts -----

INTRODUCTION

(Slide 1)

3. In order to simplify Identification and measurement of directions, the earth has been marked by number of imaginary but well defined lines. Over the years, these lines have been recognized and accepted as important symbols by all countries.

AIM

(Slide 2)

4. To teach the cadets various definitions used in air navigation.

PREVIEW

(Slide 3)

5. The lecture will be conducted in the following parts:-
 - (a) Part-I : Lines on earth.
 - (b) Part-II : Associated definitions.

LINES ON EARTH

(Slide 4)

6. The earth is an oblate spheroid whose polar diameter is 23NM less than the equatorial diameter which is 6884NM. However for the purpose of air navigation the earth is considered to be a perfect sphere. On this sphere a number of imaginary lines are drawn to understand and simplify air navigation. It is essential to understand these lines before proceeding further in the subject of air navigation.

DEFINITIONS

(Slide 5-8)

7. (a) **Great Circle** : The circle drawn on the surface of the earth whose plane cuts the earth into two equal halves, eg- the Equator, meridians together with their anti meridians.
- (b) **Small Circle**: The circle on the surface of the earth which cuts the earth into two parts which are unequal. It follows that the plane of a great circle always passes through the centre of the earth but that of a small circle does not. e.g.- parallels of a latitude.
- (c) **Rhumb Line**: The line cutting all the meridians at the same angle. It thus becomes a regularly curved line. The examples are the Equator and all the meridians.
- (d) **Equator**: It is a great circle whose plane is perpendicular to axis of rotation of the earth. The equator lies in a east-west direction and divides the earth into northern and southern hemispheres.
- (e) **Earth Axis**: It is a vertical line joining the two poles of the earth, lying perpendicular to the equator and passing through the centre of the earth.
- (f) **Meridian**: A meridian is a half great circle joining the two poles. Every great circle joining the two poles is a meridian and its ante-meridian indicates the North-South direction. A meridian together with its ante meridian is a great circle.
- (g) **Latitude**: These are the angular distances along the meridians. The latitude of a place is defined as the arc of its meridian between the equator and the place and is named North or South depending upon its corresponding position in respect to the equator. The latitude is measured in degrees, minutes and seconds from 0° to 90° from the equator.
- (h) **Longitude**: These are angular distances along the equator on east or west of the prime-meridian. The longitude of a place is defined as the shorter arc of the equator between the meridian of the place and the prime-meridian. It is measured in degrees, minutes and seconds from 0° to 180° along with suffix East or West of the Prime-Meridian.

(j) **Prime-Meridian**: The meridian passing through Greenwich Village of England which is the datum for record.

CONCLUSION

(Slide 9)

8. Although the earth is egg shaped, for navigation purposes it is considered as a perfect sphere. By understanding the various definitions in relation to earth as a perfect sphere will simplify studying air navigation. These lines are accepted internationally and are used in calculations and forming various navigation formulae.

MAPS**(NV-3)**

Period	-	IV
Type	-	Lecture
Year	-	III
Revised by	-	

Trg Aids

1. Computer slides, pointer, black board, chalk, different scale maps and charts.

Time Plan

2.	(a)	Intro	-	05 mts
	(b)	Types of maps	-	10 mts
	(c)	Different symbols used in maps	-	10 mts
	(d)	Different scales of topographical maps	-	10 mts
	(e)	Conclusion	-	05 mts
		Total		----- 40 mts -----

INTRODUCTION

(Slide 1)

3. Topographical map is one in which a good pictorial representation of a country is portrayed and is provided mainly to be used for map reading.

AIM

(Slide 2)

4. To teach the cadets about types of maps, different symbols used in maps and different scales of maps.

PREVIEW

(Slide 3)

5. The lecture will be conducted in the following parts:-

(a)	Part-I :	Types of maps
(b)	Part-II :	Symbols used
(c)	Part-III :	Scales of maps

TYPES OF MAPS

(Slide 4-6)

6. The four basic elements required in a map are:
- (a) Areas will be shown correctly
 - (b) Bearing measurement anywhere on the reduced earth will be identical to the measurement on the earth.
 - (c) Shapes will be correct
 - (d) Distances will be measured accurately by use of a graduated scale which is provided at the bottom of each map. The distances are given in (1) Kilometers (2) Nautical miles (3) Statute miles
7. In aviation both maps and charts are used for Navigation. When a projection has a graticule of latitudes, longitudes and an abundance of ground features it is called a map. A chart has a projection on which it contains a graticule of latitude and longitude with very few geographical features.
8. **Relief** : Mountains, hills, coast lines and other natural features are of considerable interest to a pilot as they are valuable landmarks for navigation purpose or are, sometimes pose dangerous barriers for flight. Relief is indicated on maps and charts in one or more of five different ways:
- (a) Spot heights or depths
 - (b) Contours and form lines
 - (c) Layer tints
 - (d) Hachures
 - (e) Hill shading

Spot heights and depths: These are shown against places where the exact height above sea level or depth below mean sea level has been measured. On some maps, heights are recorded in feet. On other maps the height is recorded in meters. One has to be very particular to note the units of heights shown on maps.

Contours and form lines: Contours are lines joining all places having the same heights above a certain datum level. When these lines are shown approximately then they are known as form lines. The closeness of the contours on a map shows the steepness of any hill. Where the changes of height is rapid, the contours will be closer than on slopes where they are spaced.

Layer tints: These are commonly used on maps to show relief. Layers of earth between certain contours are coloured with the tint intensifying with successive increase in height. Thus at a glance, a map will indicate major irregularities in the surface of the country.

Hachures: These are short, tapering lines drawn on maps and they radiate from peaks and high ground. They only serve to show slopes.

Hill shading: This is produced by assuming that a bright light is shining across the map sheet so that shadows are cast by all high ground on its lower side. The effect is to give the map something of a stereoscopic appearance by optical illusion. These shadows obliterate other details on the map and are not commonly used.

SYMBOLS USED IN MAPS

(Slide 7-9)

9. The details on topographical maps are shown by symbols. Some of which are pictorial in nature, while others are given by a symbol which is accepted internationally. These symbols are used to denote the details of a map and these are called as conventional signs.

10. The signs are uniform on all maps but the colour used may vary on different scale maps. Therefore, it is difficult to give a complete list of conventional signs used on various maps. However, all maps have a list of signs marked on the side of map and these should be studied before using the map for reading purposes.

11. Knowing the amount of details to be expected on maps of different scales and given knowledge of conventional signs by which that detail is indicated, the map reader is in a position to appreciate the relative value of the feature seen on the ground. The beginner is sometimes confused by the amount of detail confronting to his untrained eye. He must learn to distinguish the more significant features and to remain undistracted by irrelevant back ground. The following may help to indicate the types of which is of value to the map reader.

- | | | |
|------------------------|--------------------|-------------------------|
| (a) Coast line | (b) Water Features | (c) Mountains and hills |
| (d) Towns and Villages | (e) Railways | (f) Roads |
| (g) Wooded areas. | | |

SCALES OF MAPS

(Slide 10-11)

12. The scale is the ratio of a distance measured on the map to the corresponding distance on the earth surface. Scales on a map is represented commonly by (1) representative fraction (2) graduated scale line or by (3) statement in words.

13. Most common maps used in aviation are $\frac{1}{4}$ million maps, $\frac{1}{2}$ million maps and 1 million maps. $\frac{1}{4}$ million maps have larger scale than $\frac{1}{2}$ million and $\frac{1}{2}$ million have scale larger than 1 million. A larger scale map represents comparatively lesser ground distance and consequently more ground details can be inserted.

CONCLUSION

(Slide 12)

14. Maps and charts are used for plotting and planning purposes in navigation. It is essential to understand various scales, symbols and methods by which relief features are represented in a map for effective planning and subsequent reading. Before execution of navigation sortie a pilot must thoroughly go through map preparation, distance measurement and other calculations to be able to conclude the sortie accurately.

MAP READING**(NV-4)**

Period - V
 Type - Lecture
 Year - III
 Revised by -

Trg Aids

1. Computer slides, pointer, black board, chalk and ½ million map.

Time Plan

2.	(a)	Intro	-	05 mts
	(b)	Map reading procedure	-	15 mts
	(c)	Ground features	-	15 mts
	(d)	Conclusion	-	05 mts
		Total		----- 40 mts -----

INTRODUCTION

(Slide 1)

3. Requirement for successful navigation are:-
 - (a) Accurate pre-flight planning
 - (b) Accurate flying (steering accurate courses, maintaining correct IAS, maintaining accurate height)
 - (c) Good map reading (without jumping to conclusions)
 - (d) Attention to ETA's and change of ETA's if necessary

AIM

(Slide 2)

4. To teach the cadets the correct map reading procedure and discuss about the ground features.

PREVIEW

(Slide 3)

5. The lecture will be conducted in the following parts:-
- (a) Part-I : Map reading procedure
 - (b) Part-II : Ground features

MAP READING PROCEDURE

(Slide 4-6)

6. **Map Reading:-** Fixing of position in the air by means of map reading is vital. While many flights are made either in clouds or above clouds and during the bad visibility time, one makes a reference to the map to find out the aircraft position. Ability to recognize on the map what is seen from the aircraft and vice-versa is very valuable. A navigator must be able to interpret at a glance the map or chart. He must know the scale of the map, For map reading, the most important factor is ORIENTATION OF MAP or in other words, correct alignment of the map in the direction one is flying. By doing this, he will be looking down his required track in the same direction as his aircraft is heading. Once he has made sure of his position by map reading, the same must be checked and double checked with other references. Jumping to a conclusion at once, might prove wrong. Map reading differs with the time of light, as well as at night and in bad visibility. Good map reading is attained by constant practice. The first essential is to have a rough idea of the position of the aircraft and then he must be able to anticipate ahead.

7. **Anticipation:-** It is very important ingredient of map reading exercises and unless one learns to expect major points and looks ahead for them map reading falls into retrospect, thus making it impossible to make D.R. correction. Features or pin points should always be cross checked with other features as jumping to conclusions may prove disastrous.

8. **Attention to ETAS:-** Anticipation of features help the Pilot Navigator to keep a check on time. When ground speed is known, time to main features can be calculated in advance and marked on the map. If there is a need to change in the timing, calculations of ultimate change in ETA by fractional proportion are easily possible. A good check on ground speed will automatically ensure correct ETA at destination.

GROUND FEATURES

(Slide 7-9)

9. Map reading is always not an easy job. No map can look precisely like the earth itself. Symbols are used to represent ground features and the selection of symbols and features to show is not simple. Effort is made to represent those characteristics which have the most distinctive appearance when seen from the air and avoid those which would make the map a hopeless clutter.

10. Cultural features and terrain features are two general types of information appear on maps. Cultural features are man made features such as cities and towns, roads, railway, bridges, dams, race tracks, tower obstructions etc. They are the easiest a beginner can use. Once properly identified a cultural feature would provide a pin point fix more readily. Terrain features are like rivers, mountain peaks, coastlines, lakes, islands etc which provide excellent check points. Greater skill is required to use most of this information as colour shading is used for terrain height, green colour reflecting low elevations and brown colour representing higher elevations. Contour lines are also used to represent elevation.

Map Reading Aids

11. (a) **Relief:** The most important signs are those indicating the height and shape of high round.
- (b) **Water Resources:** The line separating land from water, in any form shows up more distinctly from air than does any other type of landmark. This is true not only during day light but at night as well.
- (c) **Hills:** Usually, hills and mountains are next in importance to water features, though their value will vary with terrain. For example a peak rising 300 feet above the surrounding has little value in the Himalayas but great value in a flat desert area.
- (d) **Railways:** Railways narrow down the position if their bearing is known, or if the pattern is distinctive. Examples of pattern would be long straight stretches, isolated functions, a radical change of direction etc.
- (e) **Roads:** Only broad arterial roads are likely to be of much of use, if they are not camouflaged by forest, sand etc. Roads are indicated in red lines on maps.

CONCLUSION

(Slide 10)

12. Map reading is an art and requires thorough practice by student pilot. Successful map reading depends on correct interpretation of the symbols, anticipation and accurate flying skills.

CHAPTER – VIII
Meteorology

IMPORTANCE OF MET IN AVIATION**(MET-1)**

Period - I
 Type - Lecture
 Year - II
 Revised by -

Trg Aids

1. Computer slides, pointer, black board and chalk.

Time Plan

2.	(a)	Intro	-	05 mts
	(b)	Imp of MET in aviation	-	15 mts
	(c)	Application in aviation	-	15 mts
	(d)	Conclusion	-	05 mts
		Total		----- 40 mts -----

INTRODUCTION

(Slide 1)

3. Meteorology is the study of the atmosphere and the weather processes that occur in it. Since an aircraft is flown through a medium of the atmosphere, an aviator must have adequate knowledge of meteorology and an appreciation of the effect of weather on all aspects of flying.

AIM

(Slide 2)

4. To teach the cadets about importance of met in aviation and its various application in aviation.

PREVIEW

(Slide 3)

5. The lecture will be conducted in the following parts:-
 - (a) Part-I: Importance of met in Aviation.
 - (b) Part-II: Application of met in Aviation.

IMPORTANCE OF MET IN AVIATION

(Slide 4-6)

6. Since meteorology is the science dealing with the study of atmosphere and an aircraft is designed to fly through this medium, various weather processes and changes that occur in the atmosphere has great significance for aviators.

7. Weather is global in nature and atmospheric changes occur on scales ranging from a few centimeters to thousands of kilometers. To understand the larger scale phenomena, it is necessary to observe the behavior of the atmosphere simultaneously over large parts of the globe. This is possible only if the effort is one of international co-operation. The World Meteorological Organization (WMO) provides the forum for such co-operation. In matters concerning weather services for aviation, the WMO works in close collaboration with the Met Division of the International civil Aviation Organization (ICAO). India is a member of WMO and Meteorological Services in India are provided by India Meteorological Department (Met D).

8. Meteorological forecasts and observations forms an integral part of flight planning for safe execution of flight. Meteorological occurrences like thunder storm, snow storm, heavy rains, low visibility, high temperatures, dense fog, wind shear etc have disastrous consequences to conduct of flight. Hence it is mandatory for aviators to be briefed about the likely occurrences of any such phenomena which is likely to endanger a safe flight and take avoidance action.

9. Meteorological briefing is undertaken to explain to the aircrew the prevailing met conditions and expected conditions (forecast) over the required areas of operation. It is called mass Met briefing when briefing is done for a large body of People. In a mass met briefing, the met officer gives the following information:-

(a) Salient features observed on latest weather charts.

(b) Present state of weather at base and diversionary air fields with emphasis on the aspects that are adverse for flying.

(c) Forecast for base and diversionary airfields for the next 6-12 hours with specific mention of weather warnings that may be in force and the likelihood of its extension.

10. Met briefing always precedes the flight planning stage. Cooperation between met section and aircrew are essential to maintain a high standard of accuracy in forecasting weather.

APPLICATIONS IN AVIATION

(Slide 7-8)

11. Meteorological information is useful for aviation in the following ways:-

(a) It enables a proper selection of site for an airfield and correct orientation of runways.

(b) It helps engineers to design aircraft suitably by giving them data of pressure, wind, temperature and turbulence characteristics of the atmosphere at various levels.

(c) It assists in accurate planning and correct execution of take off, climb, cruise, descent/diversion, approach and landing of an aircraft.

12. The long term aspect of weather is climate. The physical state of atmosphere at a given place and time is weather. Weather is described in terms of the instantaneous values or short period mean values of the met element. In climatology the elements studied are the same as in Weather, but the period of averaging takes several days, months, years or even centuries.

13. Once these statistics are formulated it becomes relatively easier to forecast the weather occurrences likely during the month and even during day. These forecasts are important for aviators for planning purposes.

CONCLUSION

(Slide 9)

14. Knowledge of weather conditions likely to be encountered during a specific flight enables the aviator to plan his flight with a view towards economy of fuel, operational efficiency and flight safety.

ATMOSPHERE**(MET-2)**

Period	-	II
Type	-	Lecture
Year	-	III
Revised by	-	

Trg Aids

1. Computer slides, pointer, black board and chalk.

Time Plan

2.	(a)	Intro	-	05 mts
	(b)	Atmosphere – Composition of Air	-	10 mts
	(c)	Layers of atmosphere	-	10 mts
	(d)	Atmospheric pressure	-	10 mts
	(e)	Conclusion	-	05 mts
		Total		----- 40 mts -----

INTRODUCTION

3. The invisible and odorless gas which we breathe, which sustains life and produces an infinite variety of phenomena is what we call air. The envelope of air surrounding the earth and extending to great heights is the atmosphere where vast physical processes occur, giving rise to the ever changing weather phenomena.

AIM

4. To teach the cadets about atmosphere, its air composition, layers of atmosphere and atmospheric pressure.

PREVIEW

5. The lecture will be conducted in the following parts:-
- (a) Part-I: Composition of air.
 - (b) Part-II: Layers of atmosphere.
 - (c) Part-III: Atmospheric pressure.

COMPOSITION OF AIR

6. Air is a mechanical mixture of a variety of gases. The main constituents of this mixture are nitrogen and oxygen, accounting for almost 99% of the whole, with roughly three parts of nitrogen to one part of oxygen. There are small amounts or traces of other gases. This composition is more or less the same upto about 60 kilometers.

7. The percentage of composition of dry air by volume is in the proportions as shown below:-

Nitrogen	-	78.09 %
Oxygen	-	20.95 %
Argon	-	0.93 %
Carbon dioxide	-	0.03 %

8. The atmosphere is never completely dry. Water vapours are always present in varying amounts. Water vapours also behave as a gas. It is the change in the amount and state of the water vapours (solid, liquid, gas) which is important in the physics of the weather processes in the atmosphere. Apart from water vapours suspended particles like dust, smoke and other impurities affect the transparency of the atmosphere causing reduction in visibility.

9. In the higher layers there is a concentration of Ozone between 30 and 50 km.

LAYERS OF ATMOSPHERE

10. While the pressure and density decrease as the height increases, the variation of temperature is different. Due to this there is a tendency for the atmosphere to be divided into several spheres as mentioned below:-

- (a) Troposphere - Up to about 11-16 km
- (b) Stratosphere - Up to about 50 km above troposphere
- (c) Mesosphere - 50 to 85 km
- (d) Thermosphere - Above 85 km

11. **Troposphere**: The troposphere is the region nearest to the earth and is generally the region of weather. It has a more or less uniform decrease of temperature with height. The lapse rate is roughly $6.5^{\circ}\text{C}/\text{km}$ ($1.98^{\circ}\text{C}/1000\text{feet}$). The upper boundary of the troposphere is called the tropopause whose height varies from equator to the poles, being highest at the equator (16-18 km) and lowest over poles (8-10 km).
12. **Stratosphere**: The stratosphere is the layer extending from the tropopause to about 50 km. the temperature in this region is steady or increases with height. In the higher stratosphere the temperature is of the order of 0°C . The upper boundary of the stratosphere is the stratopause.
13. **Mesosphere**: The layer above the stratosphere is the mesosphere, where the temperature again decreases with height. The boundary of the mesosphere is the mesopause, about 85 km high, where the lowest temperatures in the atmosphere are found (about -90°C).
14. **Thermosphere**: Above the mesosphere is the thermosphere. Its upper limit is undefined. However at about 700 km, the gravitational pull of the earth is practically absent and the particles can escape from the atmosphere into space. This region is often referred to as exosphere.
15. **Ionosphere**: The lower thermosphere is in a highly ionized state and is hence called ionosphere. This layer causes reflection of radio waves and makes long wave radio communication possible.
16. **International Standard Atmosphere**: A standard average atmosphere has to be specified for various purposes like the design and testing of aircraft, evaluation of aircraft performance, calibration of pressure altimeter etc. For this purpose a standard atmosphere is defined and used as a basis of references. The most widely used atmosphere for reference purposes is the one defined by ICAO, known as International Standard Atmosphere (ISA) whose specifications are :-

Mean Sea level temperature	-	15°C
Mean Sea level pressure	-	1013.25 mb
Surface density	-	1225 g/m^3
Acceleration due to gravity	-	$980.665\text{ cm / sec}^2$
Rate of fall of temp with height up to 11 km	-	6.5°C / km ($1.98^{\circ}\text{C / 1000}$)

ATMOSPHERIC PRESSURE

17. Pressure as weight of the air above: Atmospheric pressure at any level in the atmosphere refers to the weight of the column of air of unit cross section vertically above the point of observation. In other words air has weight and therefore exerts a pressure which is equivalent to a column of air extending vertically till the total height of atmosphere. This pressure is expressed in various units like millibars, pounds per square inch etc.

18. When an aircraft climbs away from the earth surface the height of the column of air above it decreases and therefore the weight and pressure exerted by that column decreases (Atmospheric pressure decreases with height). This rate of decrease of atmospheric pressure is found to be 1millibar for every 30 feet of height (and vice-versa).

CONCLUSION

19. The atmosphere extends from the surface of earth till about 500 miles. Troposphere is the layer closest to earth surface and is most important to aviation. Weather processes occurring in troposphere affects aviation. Atmospheric pressure vary from place to place depending on temperature and cause high pressure and low pressure areas. Air moves from high pressure to low pressure area and this motion of air is called wind. Wind has both direction and speed.

CLOUDS AND PRECIPITATION**(MET-3)**

Period - III
 Type - Lecture
 Year - III
 Revised by -

Trg Aids

1. Computer slides pointer, black board and chalk.

Time Plan

2.	(a)	Intro	-	05 mts
	(b)	Definition and formation of clouds	-	10 mts
	(c)	Classification of clouds	-	10 mts
	(d)	Types of precipitation and aviation Hazards	-	10 mts
	(e)	Conclusion	-	05 mts
		Total		----- 40 mts -----

INTRODUCTION

(Slide 1)

3. Clouds and precipitation are major aviation weather hazards and need to be well understood. From a brief observation of the sky two fundamental characteristics of clouds become apparent. Their infinite variety of form and their continual change in appearance. The study of the cloud is one of the fascinating aspects of weather science and important tool of weather forecasting. Clouds form in the sky, develops, take different shapes and dissolve. Each process is an indication of some physical state in the atmosphere.

AIM

(Slide 2)

4. To teach the Cadets about clouds, their formation classification and discuss types of precipitation and associated aviation hazards.

PREVIEW

(Slide 3)

5. The lecture will be conducted in the following parts:-
- (a) Part-I: Definition of clouds, its formation and its classification.
 - (b) Part-II: Types of precipitation and associated aviation hazards.

CLOUDS

(Slide 4-6)

6. The clouds may be defined as visible aggregate of minute particles of water or ice or both in the free air. Clouds are formed by cooling of masses of damp air, generated by upward motion and its accompanying expansion with fall of pressure. The essential difference between clouds of various forms or types are due to their varying nature of the ascending motion which produces them. The Ascending motions which may be effective in producing clouds may be classified in the following manner.

- (a) Turbulent motion, leading to numerous small scale upward currents.
- (b) Uphill currents over sloping grounds.
- (c) Large scale convection as a result of surface heating.
- (d) Currents of warm moist air moving upward over a wedge of cold air and cold air acting in the same way as the sloping ground cited above.

CLASSIFICATION OF CLOUDS

7. The number of forms which clouds may take, is almost infinite, but for the purpose of description, it is necessary to adopt some kind of classification. The system of classification which have been proposed, have sometimes been based on the observed appearance of the clouds and at the other times on the supposed method of formation. There can be no doubt that the former is the correct method since an observer is able to judge definitely the appearance, whereas, the method of the formation must be, to some extent, a matter of opinion.

8. The international cloud classification is based upon the appearance of clouds and consists of four families of classes depending upon the heights at which they form. Each class is further sub-divided into two or three forms according to their appearance.

Class of family	Average height of base	Forms
High Clouds	20,000 feet and above	Cirrus, Cirro-Stratus, Cirro-Cumulus.
Medium Clouds	6500 feet to 20,000feet	Alto-Stratus,Alto-Cumulus, Numbo-Stratus(At low altitudes)
Low Clouds	Ground level to 6500 feet	Stratus, Strato-Cumulus.
Clouds with vertical development	Base 1500 feet to 6500 feet but tops reaching high and medium cloud levels	Cumulus, Cumulo-Nimbus.

Significance of Prefixes And Suffixes

9. Cirrus or prefix 'Cirro' means high clouds, prefix alto means medium clouds, stratus means layer type and cumulous means heap type.

High clouds

- (i) **Cirrus (Ci)** - Detached clouds in the form of white, delicate filaments or white or mostly white patches or narrow bands. These clouds have fibrous (hair like) appearance.
- (ii) **Cirro cumulous (Cc)** – Thin white patch, sheet or layer of cloud without shading, composed of very small elements in the form of grains, ripples etc. They are seen merged or separate and more or less regularly arranged.
- (iii) **Cirro stratus (Cs)** – They are transparent whitish cloud with a veil of fibrous or smooth appearance, totally or partly covering the sky.

Medium clouds

- (i) **Alto cumulous (Ac)** – White or grey or both white and grey patch, sheet or layer of cloud generally with shading.
- (i) **Alto stratus (As)** – Greyish or bluish cloud sheet or layer of striated, fibrous or uniform appearance, totally or partly covering the sky.

Low clouds

- (i) **Nimbo stratus (Ns)** – They are grey cloud layer often dark. They are associated with continuous falling of rain or snow. It is a thick through out.
- (ii) **Strato cumulous (Sc)** – Grey or whitish or both grey and whitish patch, sheet or layer of cloud.
- (i) **Stratus (St)** – These are generally grey cloud layer with a fairly uniform base, which may give drizzle or snow grains.

Clouds with vertical development

- (i) **Cumulous (Cu)** – These are detached clouds, generally dense and with sharp outlines developing vertically in the form of rising mounds, dome or towers. The bulging upper part often resembles a cauliflower. The sunlit part of these clouds are brilliantly white where as their bases are relatively dark and horizontal.
- (ii) **Cumulo nimbus (Cb)** – it is a heavy and dense cloud with considerable vertical extent in the form of a mountain or huge towers. Its base is often vary dark and while dissipating its top forms the shape of an anvil.

PRECIPITATION

10. Precipitation is the general term used for drizzle, rain, shower, sleet and snow i.e. water droplets or ice crystals falling from clouds.

TYPES OF PRECIPITATION

11. Water droplets or ice crystals in a cloud are usually of such small dimension that they are kept suspended in mid air by the vertical current at the base of the cloud. These vertical currents are a necessary contribution for the formation of clouds and their maintenance. For the water droplets or ice crystal to overcome the vertical currents and fall under the force of gravity, their diameter should be of the order at least a millimeter or more.

- (i) **Drizzle** - Minute water drops falling from the clouds. The drops are so small that they look like spay and are at times blown and carried by wind.
- (ii) **Rain** – Medium size water drops falling from layer types of clouds.
- (iii) **Snow** – Frozen rain in the form of flakes or ice crystal.
- (iv) **Sleet** – Mixture of rain and snow.
- (v) **Shower** – Large drops falling from heap type of clouds.
- (vi) **Thunder storm** – A phenomenon in which thunder is heard and lightning is seen. Generally accompanied by sharp shower. They are associated with Cb clouds.
- (vii) **Hail storm** – A storm in which solid pellets of ice fall on the ground.

Flying hazards in thunder storm

12. Thunder storms pose variety of hazards to aircraft in flight. The more important ones are:

- (a) **Squall**: Sudden increase in wind speeds and possible changes of direction.
- (b) **Heavy showers**: These may reduce ground visibility to vary low values for short durations
- (c) **Low clouds**: Low clouds with base as low as 100 meter over plain ground and over high terrain the hills may be completely covered.

- (d) **Poor in flight visibility**: In the interior of Cb cloud the in flight visibility will be practically nil.
- (e) **Draughts**: Within the cloud, strong updraughts and downdraughts may cause sudden and large variations in the altitude of an aircraft.
- (f) **Gusts**: Cause extreme bumpiness within the cloud.
- (g) **Ice accretion**: Cb clouds have super cooled water drops which can cause icing up to great heights.
- (h) **Hail**: Hail formed in well developed Cb clouds can strike an aircraft.
- (j) **Lightning**: Apart from distracting and temporally blinding the eyes, lightning may interfere with radio communication and may seriously affect magnetic compass.

CONCLUSION

13. Many flying accidents can be attributable to flying in the clouds and through heavy precipitation. Apart from disorientation causes difficulty in judgment, controllability of aircraft, wrong decision making due to poor visibility whenever the flight is not supported by suitable avionics. Under such conditions it is always wise to avoid or divert the aircraft to a suitable base reporting good weather.

VISIBILITY**(MET-4)**

Period - IV
 Type - Lecture
 Year - III
 Revised by -

Trg Aids

1. Computer slides, pointer, black board and chalk.

Time Plan

2.	(a)	Intro	-	05 mts
	(b)	Importance of visibility in aviation and Types of visibility	-	15 mts
	(c)	Causes of poor visibility and its aviation hazards	-	15 mts
	(d)	Conclusion	-	05 mts
		Total		----- 40 mts -----

INTRODUCTION

(Slide 1)

3. Visibility is the term used to describe the transparency of the atmosphere. It is the measure of maximum distance to which a person with normal vision can see an object and recognize it as such.

AIM

(Slide 2)

4. To teach the cadets about Importance of visibility, types of visibility, causes of poor visibility and its hazards.

PREVIEW

(Slide 3)

5. The lecture will be conducted in the following parts:-
 - (a) Part-I: Importance of visibility, types of visibility
 - (b) Part-II: Causes of poor visibility and its hazards

IMPORTANCE OF VISIBILITY AND TYPES OF VISIBILITY

(Slide 4-6)

6. An aviator's interest in visibility arises because he wants to know how far he will be able to see various things like landmarks, targets, observations, beacon lights, other aircraft, runways etc, while he is in flight or when he is about to make an approach and landing.
7. Although all these questions cannot be fully answered by Met personnel on the ground, met reports of visibility from ground section provide an aviator with vital information which may prepare him mentally for a different landing or a diversion.
8. At some airfields, blind landing systems like ILS, GCA etc are provided for guidance of aircraft for landing under conditions of poor visibility. Even these systems have their limitations. A large number of airfields in India does not have these aids. Thus, even for experienced aviators, poor visibility still remains a serious hazard.

VISIBILITY OBSERVATIONS

9. The visibility reported by the met section has the following limitations :-
 - (a) The report gives horizontal visibility at the ground level. This will be different from vertical and slant visibilities.
 - (b) The report gives the lowest visibility after scanning all directions, though visibility can be substantially different in different directions.
 - (c) Estimate of visibility depends on the illumination of the landmarks selected for observation.
 - (d) Visibility reported at night is actually an estimate of the equivalent day time visibility.

TYPES OF VISIBILITY

10. Three types of visibility affecting aviation are horizontal visibility, slant visibility and vertical visibility. Slant and vertical visibilities being reported from inflight. When a shallow layer of haze or fog is covering an airfield, the horizontal ground visibility will be poor. However an aviator flying over the airfield above the haze layer may be able to see the airfield clearly. This can be deceptive since on approach for landing he would suddenly encounter poor visibility and perhaps lose sight of runway.

CAUSES OF POOR VISIBILITY AND HAZARDS

(Slide 7-9)

11. Poor visibility of layers near the ground may be caused due to various phenomena. Some of the main causes affecting visibilities is as follows:-

(a) **Dust haze** : Wide spread dust held in suspension for a number of days due to persistent strong winds caused by steep pressure gradient especially over desert and semi-arid regions. In this case the visibility gets affected for days together reducing visibility below 5 km.

(b) **Dust raising winds** : When strong winds also occur with dust haze, the dust is carried to great distances and vertically to 3 to 5 km. The visibility drops less than 1000 mtrs.

(c) **Dust storm**: Visibility in a dust storm is less than 1000 mtrs and this last for short durations. However visibility remains poor once the storm passes away due to suspended dust and improves rapidly if followed by a light shower.

(d) **Smoke haze**: Smoke emitted from industrial or domestic sources spreads as a haze layer when the wind is calm or very light. Under extreme conditions ground visibility reduces to 1000 mtrs but usually it is of the order of 2 to 5 km.

(e) **Moist haze**: Moist haze usually occur in the early morning and dissipates soon due to the heating by the sun. it is principally a winter hazard in the wake of clear skies and consequent increased cooling at night. Visibility is of the order of 2 to 5 km and relative humidity is 75 % or more.

(f) **Mist**: When moist haze thickens and the visibility is between 1 and 2 km. Relative humidity is 75 % or more.

(g) **Fog**: When visibility deteriorates to less than 1 km due to condensed water vapour and relative humidity 75 % or more.

(h) **Smog**: Radiation fog and smoke haze may coexist giving raise to extreme poor visibility condition called smog.

12. Under all the above mentioned causes the visibility falls below 5 km and in extreme conditions of dense fog it can be nil also. This poor visibility conditions affect safe conduct of flights and aircrew must be prepared to divert to an airfield reporting better visibility.

CONCLUSION

(Slide 10)

13. Visibility forms an important aspect of safe conduct of flying. However with modern avionics and nav aids this aspect is overcome to certain extent. But most airfields in India does not support such modern nav aids and compounded by insufficient avionics on board will stretch the capability of both aircraft and aircrew in case of poor visibility conditions and it not careful can lead to disastrous consequences.

HUMIDITY AND CONDENSATION**(MET-5)**

Period - V
 Type - Lecture
 Year - III
 Revised by -

Trg Aids

1. Computer slides pointer, black board and chalk.

Time Plan

2.	(a)	Intro	-	05 mts
	(b)	Definition and variation of humidity	-	15 mts
	(c)	Effect of condensation	-	15 mts
	(d)	Conclusion	-	05 mts
		Total		----- 40 mts -----

INTRODUCTION

(Slide 1)

3. Water vapour is very important constituent of the atmosphere so far as weather processes are concerned. For studying these processes it is necessary to know the actual water vapour content near the ground and also at various levels in the upper air.

AIM

(Slide 2)

4. To teach the Cadets about humidity, its variation and effects of condensation .

PREVIEW

(Slide 3)

5. The lecture will be conducted in the following parts:-
 - (a) Part-I: Humidity.
 - (b) Part-II: Condensation .

HUMIDITY

(Slide 4-6)

6. Humidity is the general term used for denoting the water vapour content in air. It can be expressed in several ways. The most common one used in meteorology is relative humidity.

7. The atmosphere has capacity (greater at higher temperature and lesser at lower temperature) of holding within it, invisible form of water vapour, that is, water in the gaseous form. Thus when it holds the maximum quantity of water vapour it can at any particular temperature, air is said to be saturated at that temperature. The water holding capacity of a fixed volume of air at a specified temperature is fixed.

Relative humidity (RH) At a given temperature and pressure, air can hold only a certain amount of water vapour and no more. When it holds this maximum quantity of water vapour, it is said to have reached saturation.

$$RH = \frac{\text{Actual amount of water vapour}}{\text{Amount required to reach saturation}}$$

Relative humidity is expressed as as percentage. At the stage of saturation, the RH is 100%.

Variation of Humidity

8. RH of a sample of air increases when the temperature decreases and vice versa. As long as there is no condensation taking place, absolute humidity is practically unaffected by temperature. Absolute humidity remains more or less steady as temperature does not decrease before DEW POINT which is the temperature at which the water vapour actually present in the air becomes (due to fall in temperature) sufficient to saturate air. In ascending air the relative humidity increases until it becomes saturated after which condensation occurs.

CONDENSATION

9. The conversion of water vapour into liquid form or ice form is called condensation. Few effects of condensation are as follows:

(a) Dew- At a given temperature air can hold a certain quantity of water vapour and more. The temperature at which saturation occurs is the dew point temperature, because if the air is cooled below this temperature, the extra water vapour settles down as dew ie- into small water droplets.

(b) Airframe icing- Hoar frost. When the dew point is below the freezing temperature the water condense into ice. Hoar frost occurs on an airframe in the clear air, if its temperature is below the frost point of the ambient air.

(c) Formation of moist haze, mist and fog- when air at the bottom of the atmosphere is cooled to temperature below the dew point, condensation occurs. When the cooling at the bottom is passed on by frictional turbulence to a limited height, the condensation product in the form of minute droplets of water is held in suspension in the lower layer of atmosphere giving rise to formation of fog, mist or haze depending on visibility.

(d) Precipitation- general term used for drizzle, rain, shower, snow, sleet etc. These are most common example of condensation.

(e) Contrails- They form due to moisture content in the exhaust gas condensing into visible streak of water or ice high in the atmosphere.

CONCLUSION

(Slide-7)

10. It is the water vapour present in the atmosphere that is largely responsible for trapping much of the outgoing long wave radiation from the earth. It thus prevents the surface of the earth and the lower layers of the atmosphere from getting chilled to a temperature unbearably low. Water vapour is also responsible for many of the weather phenomena which occur in the atmosphere i.e. rain, snow, thunderstorm, clouds and so on. While some of them may be nuisance to flying on occasions, it is well to remember that the very existence on earth may be threatened in their absence.

CHAPER – IX
AERO ENGINES

INTRODUCTION TO AERO ENGINES**(AE-1)**

Period	-	I
Type	-	Lecture
Year	-	I
Revised by	-	

Trg Aids

1. Computer slides, Pointer, Black board and chalk

Time Plan

2.	(a)	Introduction	-	05 mins
	(b)	Basic Theory	-	15 mins
	(c)	Components of Aero engines	-	15 mins
	(d)	Conclusion	-	05 mins
		Total		40 mins

INTRODUCTION

(Slide 1)

1. An engine is a device where-in energy in one form is converted into another form. Here the heat energy is converted into mechanical energy to produce required propulsion. The propulsion is achieved by imparting acceleration to a certain mass of gas as per Newton's third law of motion.

AIM

(Slide 2)

2. To teach the cadets about basic theory and components of Aero engines.

PREVIEW

(Slide 3)

3. The class will be conducted in the following parts:-
 - (a) Part I Basic Theory
 - (b) Part II Components of Aero engines

BASIC THEORY

(Slide 4-6)

4. Aero-engines are machines which transform the potential energy contained in fuel and air either into kinetic or mechanical energy. The gas energy is produced by the combustion of an air-fuel mixture. The forward thrust is produced as per Newton's third law which states that '**for every action, there is an equal and opposite reaction.**' The operating cycle (pressure / volume cycle) of a basic aero-engine is **Brayton cycle**.
5. **Direct reaction propulsion.**
- (a) In the case of **rockets and ram-jets**, all the gas kinetic energy is used for propulsion.
- (b) In the case of **turbo-jets**, the gas kinetic energy is partially used for propulsion, the rest is transformed into mechanical energy.
6. **Indirect reaction propulsion.** In this case, the gas kinetic energy is almost transformed into mechanical energy. Eg: - **Turbo shaft and Turbo prop engines.**

COMPONENTS OF AERO ENGINES

(Slide 7-10)

7. **Operating Phases.** There are basically five operating phases for any Aero-engine. They are as follows:-
- (a) Induction
- (b) Compression
- (c) Combustion
- (d) Expansion
- (e) Exhaust
8. In an Aero engine, the operating phases are achieved with the help of following components:
- (a) **Air intake** : Assists in induction of air
- (b) **Compressor** : Assists in compression of air
- (c) **Combustion chamber:** Assists in combustion of fuel and air
- (d) **Turbine assembly** : Assists in expansion of combustion gas
- (e) **Exhaust assembly** : Assists in exhaust of gas
9. Apart from above, aero-engine has mounted components on the engine such as Fuel pump, Oil pump, Vacuum pump, Booster pump, Generator etc. In case of four stroke engine used on small aircraft, magneto and carburetor would be fitted on the engine.

10. The figure below is the schematic diagram to illustrate the main operating phases of the aero-engine components

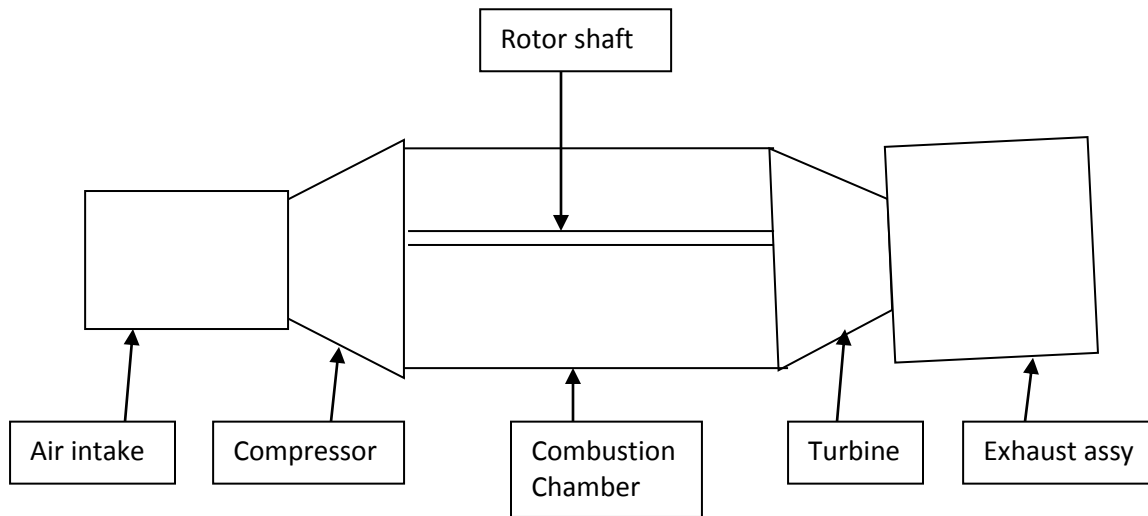

CONCLUSION

(Slide 11)

11. In any engine the basic working principle remains the same. Also, the mode of accomplishing the operating phases and the gas flow through different aero-engines more or less remains the same. The thermodynamic cycle for the operation of a basic aero-engine is Brayton cycle. However, the performance characteristics vary with varying designs of its assemblies by different manufacturers.

TYPES OF ENGINES**(AE-2)**

Period	-	I
Type	-	Lecture
Year	-	II
Revised by	-	

Trg Aids

1. Computer slides, Pointer, Black board and chalk

Time Plan

2.	(a)	Introduction	-	05 mins
	(b)	Principles of propulsion	-	15 mins
	(c)	Types of engines	-	15 mins
	(d)	Conclusion	-	05 mins
		Total		40 mins

INTRODUCTION

(Slide 12)

1. There are various types of engines in use today such as Heat engines, Electric motors, Generators, Hydro electric turbines and Wind mills. However, in the field of aviation, heat engines are of great relevance. Heat engines are devices which convert heat energy into mechanical energy.

AIM

(Slide 13)

2. To teach the cadets about principles of propulsion and types of engines.

PREVIEW

(Slide 14)

3. The class will be conducted in the following parts:-
 - (a) Part I Principles of propulsion
 - (b) Part II Types of engines

PRINCIPLES OF PROPULSION

(Slide 15-20)

4. The propulsion of aircraft is achieved by imparting acceleration to a certain mass as per Newton's third law of motion. The relation between the force ' F ' and the acceleration ' a ' imparted to the mass ' m ' is $F = ma$
5. There are two types of propulsion. They are as follows:-
- (a) **Propulsion by action.** It consists of rotating a propeller in the air so as to create aerodynamic forces and to accelerate the mass of air. In this type of propulsion, a great mass of air is expelled rearwards with a low increase of speed. This is what a propeller does on the aircraft.
- (b) **Propulsion by reaction.** In this case, the forward force is produced by expelling a mass of gas with a certain speed. In this type of propulsion, a small mass of air is expelled rearwards with a great acceleration. This is the principle of jet propulsion. If ' m ' is the mass flow of gas with ' V_1 ' as inlet velocity and ' V_2 ' as outlet velocity, then forward force ' F ' is given by ' $F = m (V_2 - V_1)$
6. **Indirect reaction propulsion.** In this case, the gas kinetic energy is almost transformed into mechanical energy. Eg: - **Turbo shaft and Turbo prop engines.**

TYPES OF ENGINES

(Slide 21-25)

7. There are two types of engines in general use. They are **External combustion engines and Internal combustion engines.**
8. **External combustion engines.** In this system, the fuel is burnt outside the engine. The example is railway locomotive, where the fuel (coal) is burnt outside the engine to generate steam which is used to power the locomotive. The figure below Shows the working of an external engine. As can be seen, the coal is burnt outside to Produce steam that is used to move a piston to produce required propulsion.

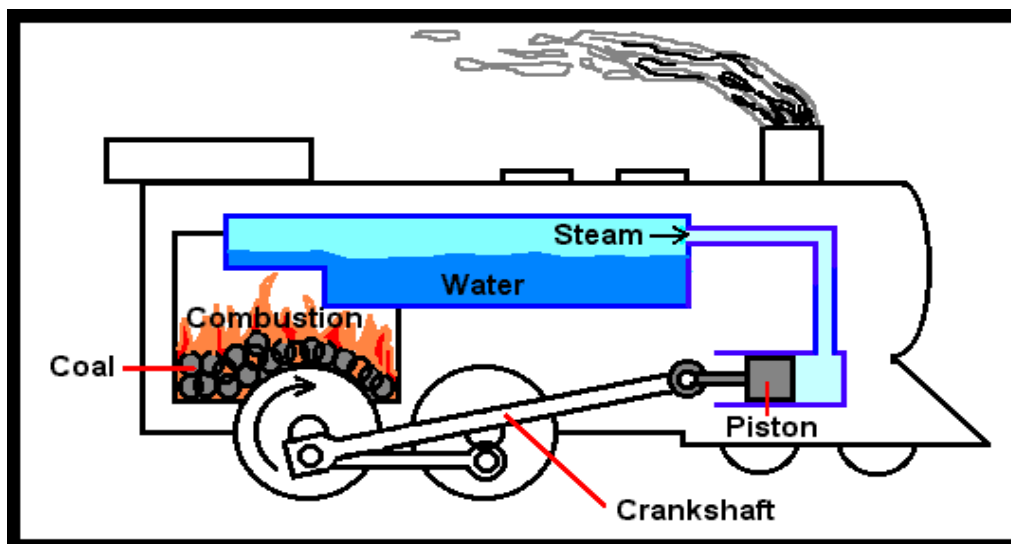

9. **Internal Combustion Engines**. In this system, the fuel is burnt inside the engine. This type of engine has become very common since it has been widely used to power motor cars, aeroplanes, ships etc.

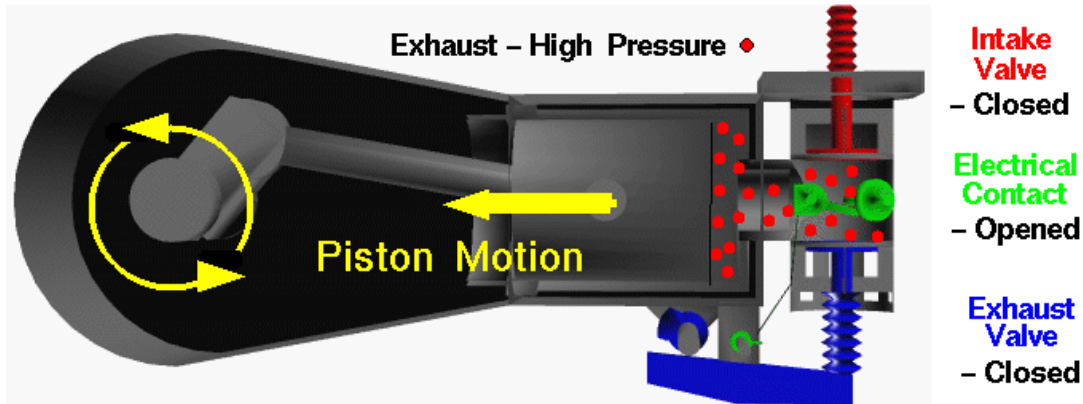

CONCLUSION

(Slide 26)

10. The principles of propulsion are basic to the understanding of any heat engine. The propulsion takes place through action or through reaction. The engines that are in use presently can be broadly classified into external combustion engines and internal combustion engines.

PISTON ENGINES**(AE-3)**

Period	-	II
Type	-	Lecture
Term	-	II
Revised by	-	

Trg Aids

1. Computer slides, Pointer, Black board and chalk

Time Plan

2.	(a)	Introduction	-	05 mins
	(b)	Basic terminology	-	15mins
	(c)	Operations	-	15mins
	(d)	Conclusion	-	05 mins
		Total		40 mins

INTRODUCTION

(Slide 27)

1. Piston engine is one of the most commonly used power plants of modern age.

AIM

(Slide 28)

2. To teach the cadets about principles and basic terminology of piston engines.

PREVIEW

(Slide 29)

3. The class will be conducted in the following parts:-

- (a) Part I Basic terminology
- (b) Part II Operations

BASIC TERMINOLOGY

(Slide 30-42)

4. The various terminologies associated with piston engines are as follows:-
- (a) **Engine cylinder.** It provides the housing for the piston to move up and down during various strokes.
 - (b) **Crank case.** It supports the crank shaft and the cylinders.
 - (c) **Spark plug.** It is fitted on the cylinder head to give spark at the plug points to ignite the mixture in the cylinder.
 - (d) **Crank.** It converts linear motion of the piston in to rotary motion of the crank shaft.
 - (e) **Connecting rod.** It connects the piston to the crank shaft.
 - (f) **Carburetor.** It supplies the correct mixture of petrol and air to the engine.
 - (g) **Fuel pump.** It sends the fuel to the carburetor under positive pressure.
 - (h) **Oil pump.** It ensures positive lubrication of the engine.
 - (j) **Generator.** It is used to provide current to the various electrical services in the aircraft.
 - (k) **Magneto.** It supplies desired high voltage current to the spark plugs.

OPERATIONS

(Slide 43-46)

5. Four stroke cycle is the sequence of operation by which the engine converts the heat energy into mechanical energy. The various strokes of the cycle are as follows:-
- (a) **Induction stroke.** In this stroke, a mixture of petrol and air is introduced into the cylinder.
 - (b) **Compression stroke.** In this stroke, the inducted mixture is compressed inside the cylinder.
 - (c) **Power stroke.** In this stroke, the heat and high pressure generated due to the spark given to the mixture at the end of compression stroke drives the piston down to the Bottom dead centre of the cylinder.
 - (d) **Exhaust stroke.** In this stroke, the waste products of the combustion are ejected out of the cylinder.

6. A simple illustration is given below for easy understanding of operation of a piston engine:-

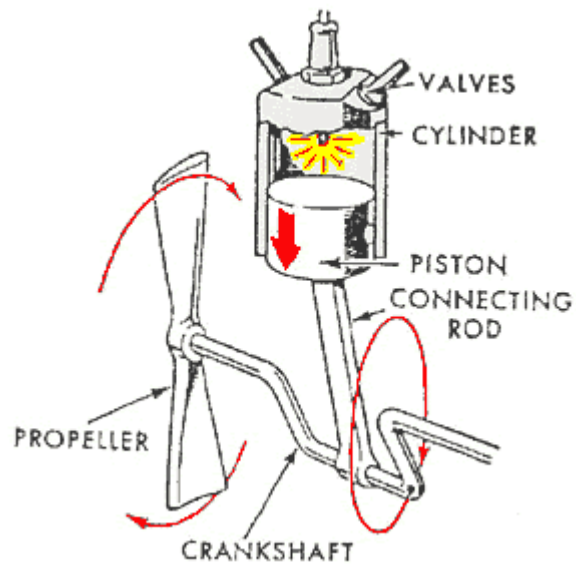

CONCLUSION

(Slide 47)

7. The knowledge of basic terminology and the operations of the piston engine are essential to understand the development of propulsive power by the engine fitted on to the aircraft. Generally most of the small sub-sonic aircraft are fitted with piston engines.

JET ENGINES**(AE-4)**

Period	-	III
Type	-	Lecture
Term	-	II
Revised by	-	

Trg Aids

1. Computer slides, Pointer, Black board and chalk

Time Plan

2.	(a)	Introduction	-	05 mins
	(b)	Basic Theory	-	15mins
	(c)	Working cycle	-	15mins
	(d)	Conclusion	-	05 mins
		Total		40 mins

INTRODUCTION

(Slide 48)

1. Gas turbine engines are divided into two main classes. They are Turbo jet engine and Turbo prop engine. Almost all the modern aircraft including military aircraft are powered by this class of engines.

AIM

(Slide 49)

2. To teach the cadets about basic theory and working cycle of jet engines.

PREVIEW

(Slide 50)

3. The class will be conducted in the following parts:-
 - (a) Part I Basic Theory
 - (b) Part II Working cycle

BASIC THEORY

(Slide 51-54)

4. The principle of operation of a jet engine is similar to a piston engine in that the processes such as induction, compression, ignition and exhaust are the same. **The main difference from piston engine is that in case of a jet engine, the processes are continuous and not intermittent which is the case with a piston engine.**
5. The ambient air enters the engine through the air intake. This air is then compressed by a multi-stage axial compressor. The combustion is achieved in an annular chamber. Gases are expelled at a high velocity, which creates the required thrust.
6. As explained, whatever the propulsion mode may be, the operating phases are similar. In a gas turbine, these phases are achieved with the following elements:
- (a) Air intake
 - (b) Compressor
 - (c) Combustion chamber
 - (d) Turbine
 - (e) Exhaust
7. The thrust produced in a jet engine can be mathematically shown. If ' m ' is the mass flow of gas with ' V_1 ' as inlet velocity and ' V_2 ' as outlet velocity, then forward thrust ' F ' is given by ' $F = m (V_2 - V_1)$ '. A basic jet engine is shown below.

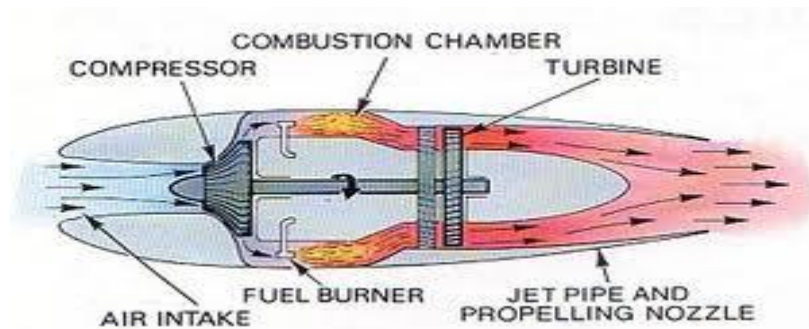

WORKING CYCLE

(Slide 55-58)

8. A basic thermodynamic cycle of a jet engine is illustrated below. This shows the variation of pressure and volume. The cycle is called Brayton's cycle.

Combustion

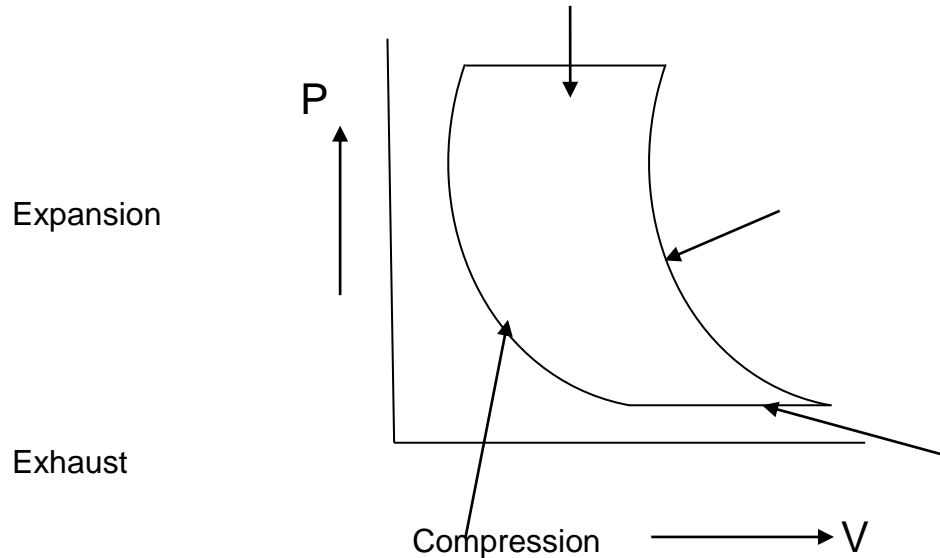
**BRAYTON'S CYCLE**

9. **Thermodynamic cycle.**

- (a) The compression is adiabatic which results in an increase in pressure and temperature.
- (b) The continuous combustion is achieved in a chamber where the pressure drops slightly while the temperature increases.
- (c) The expansion is adiabatic which results in drop of pressure and temperature.

CONCLUSION

(Slide 59)

10. Basic theory and working concept are similar to a piston engine. However, for a jet engine, the processes are continuous which ensures a smooth production of power. Almost all the modern aircraft are fitted with jet engines.

TURBO PROP ENGINES**(AE-5)**

Period	-	IV
Type	-	Lecture
Term	-	II
Revised by	-	

Trg Aids

1. Computer slides, Pointer, Black board and chalk

Time Plan

2.	(a)	Introduction	-	05 mins
	(b)	Theory	-	15mins
	(c)	Types of turbo prop engines	-	15mins
	(d)	Conclusion	-	05 mins
		Total		40 mins

INTRODUCTION

(Slide 60)

1. Turbo prop engine is a gas turbine engine which supplies mechanical energy to a propeller/set of propellers for producing the required thrust.

AIM

(Slide 61)

2. To teach the cadets about theory and types of turbo prop engines.

PREVIEW

(Slide 62)

3. The class will be conducted in the following parts:-
 - (a) Part I Theory
 - (b) Part II Types of turbo prop engines

THEORY

(Slide 63-66)

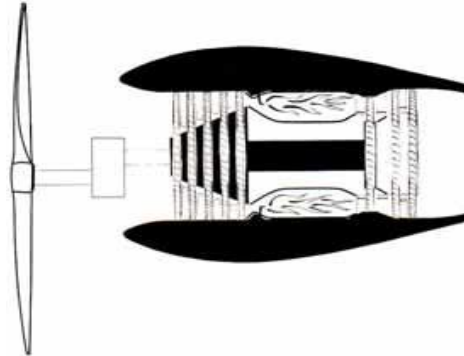

4. The gas turbine engine that is used to drive a propeller as shown above is called a turbo prop engine. A turboprop engine is simply a turbine engine where a propeller is attached to the low-pressure rotor at the front, via a gearbox. The air that passes through the propeller near its inner diameter also passes through the compressor stages in the core of the engine and is further compressed and is processed through the engine cycle. The air that passes through the outer diameter of the propeller does not pass through the core of the engine, but instead passes along the outside of the nacelle. The large volume of air pushed backward by the propeller provides airplane thrust in the same way as the smaller, high velocity air from the nozzle of a classic jet engine.

TYPES OF TURBO PROP ENGINES

(Slide 67-70)

5. There are two types of turbo prop engines:
 - (a) Single shaft engine
 - (b) Free turbine engine
6. The main difference between single shaft and free turbine engine is in the transmission of the power to the propeller.
7.
 - (a) **Single Shaft**. In a single-shaft engine, the propeller is driven by the same shaft (spool) that drives the compressor. Because the propeller needs to rotate at a lower RPM than the turbine, a reduction gear box reduces the engine shaft rotational speed to accommodate the propeller through the propeller drive shaft.
 - (b) **Free Turbine**. In a free-turbine engine, the propeller is driven by a dedicated turbine. A different turbine drives the compressor; this turbine and its compressor run at near-constant RPM regardless of the propeller pitch and speed. Because the propeller needs to rotate at lower RPM than the turbine, a reduction gearbox converts the turbine RPM to an appropriate level for the propeller.

CONCLUSION

(Slide 71)

8. Turbo props are very efficient at speeds below 450 mph (390 knots; 725 kmph) because jet velocity of propeller is relatively low. Also, compared to a turbo jet which can fly at high altitude for enhanced speed and fuel efficiency, a propeller aircraft has a much lower ceiling. Turbo props are fitted on sub sonic aircraft.

CONSOLIDATION**(AE-6)**

Period	-	I
Type	-	Lecture
Term	-	II
Revised by	-	

Trg Aids

1. Computer slides, Pointer, Black board and chalk

Time Plan

2.	(a)	Introduction	-	05 mins
	(b)	Consolidation	-	30mins
	(c)	Conclusion	-	05 mins

Total-----
40 mins
-----**INTRODUCTION**

1. Consolidation of Aero Engines.

AIM

2. To carry out consolidation of aero engines covered till now.

CHAPTER – X

AIR FRAME

AIRCRAFT CONTROLS

(AF-1)

Period	-	I
Type	-	Lecture
Year	-	I
Revised by	-	

Trg Aids

1. Computer slides, Pointer, Black board and chalk

Time Plan

2.	(a)	Introduction	-	05 mins
	(b)	Basic aircraft controls	-	30mins
	(c)	Conclusion	-	05 mins
		Total		----- 40 mins -----

INTRODUCTION

(Slide 1)

1. A conventional wing aircraft flight control system consists of flight control surfaces, the respective cockpit controls, connecting linkages, and the necessary operating mechanisms to control an aircraft's direction in flight. Aircraft engine controls are also considered as flight controls as they change speed.
2. Generally basic aircraft control can be classified as follows:
 - (a) Primary controls
 - (b) Secondary controls

AIM

(Slide 2)

3. To teach the cadets about basics on aircraft controls.

PREVIEW

(Slide 3)

4. The class on basic aircraft controls will be conducted.

BASIC AIRCRAFT CONTROLS

(Slide 4-9)

5. The basic aircraft controls are classified in to following:

(a) Primary controls. Basically, the primary cockpit flight controls are arranged as follows:

- (i) a control yoke (also known as a control column), centre stick or side-stick (the latter two also colloquially known as a control or joystick), governs the aircraft's roll and pitch by moving the ailerons (or activating wing warping on some very early aircraft designs) when turned or

deflected left and right, and moves the elevators when moved backwards or forwards

(ii) Rudder pedals, to control yaw, which move the rudder; left foot forward will move the rudder left for instance.

(iii) Throttle controls to control engine speed or thrust for powered aircraft.

Primary aircraft controls

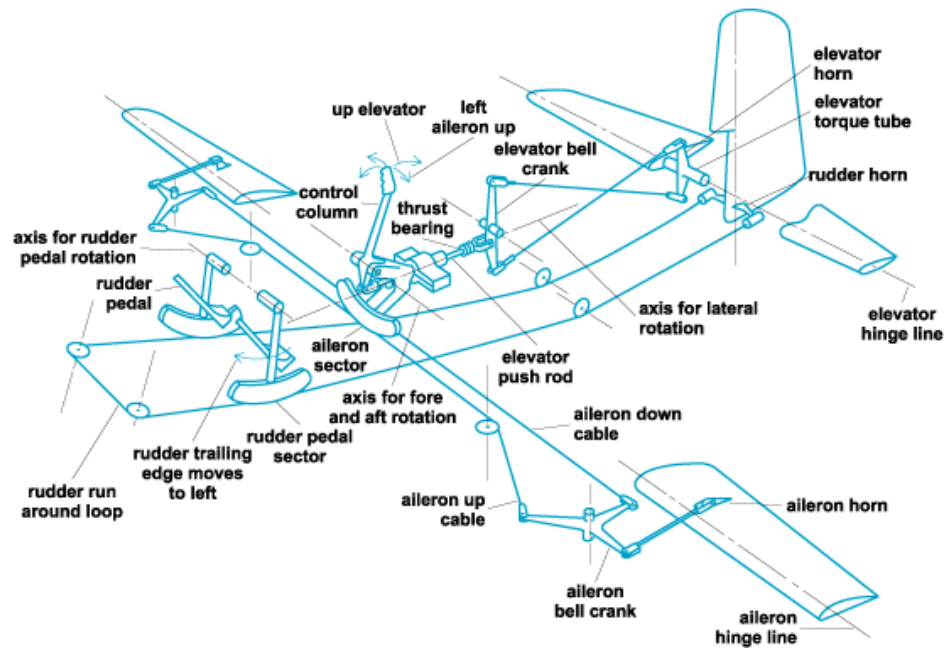

(b) Secondary controls. The secondary controls are trim tab, flap (aircraft), Air brake (aircraft), Spoiler, Leading edge slats, and variable-sweep wing.

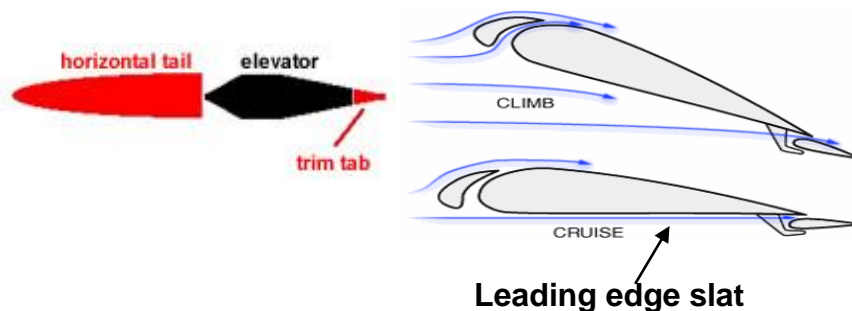

6. **Trim tabs.** These are small control surfaces connected to the trailing edge of a larger control surface of aircraft, used to control the trim of the controls, i.e. to counteract aerodynamic forces and stabilise the aircraft in a particular desired attitude without the need for the operator to constantly apply a control force. This is done by adjusting the angle of the tab relative to the larger surface. Changing the setting of a trim tab adjusts the neutral or resting position of a control surface (such as an elevator or rudder). As the desired position of a control surface changes (corresponding mainly to different speeds), an adjustable trim tab will allow the operator to reduce the manual force required to maintain that position—to zero, if used correctly. Thus the trim tab acts as a servo tab.

7. **Air brakes and Spoilers.** Air Brakes or speed brakes are a type of flight control surface used on an aircraft to increase drag or increase the angle of approach during landing. Spoilers are designed to increase drag while making little change to lift. Thus, spoilers reduce the lift-to-drag ratio and require a higher angle of attack to maintain lift, resulting in a higher stall speed. Most gliders are equipped with spoilers on the wings in order to adjust their angle of descent during approach to landing.

8. **Slats.** Slats are aerodynamic surfaces on the leading edge of the wings of fixed-wing aircraft which, when deployed, allow the wing to operate at a higher angle of attack. A higher coefficient of lift is produced as a result of angle of attack and speed, so by deploying slats an aircraft can fly at slower speeds, or take off and land in shorter distances. They are usually used while landing or performing maneuvers which take the aircraft close to the stall, but are usually retracted in normal flight to minimize drag.

9. **Variable - Sweep Wing.** A **variable-sweep wing**, colloquially known as a "swing wing", is an aeroplane wing that may be swept back and then returned to its original position during flight. It allows the aircraft's plan form to be modified in flight, and is therefore an example of a variable-geometry aircraft.

10. **Flaps.** Flaps are hinged surfaces mounted on the trailing edges of the wings of a fixed-wing aircraft to reduce the speed at which an aircraft can be safely flown and to increase the angle of descent for landing. They shorten take-off and landing distances. Flaps do this by lowering the stall speed and increasing the drag.

CONCLUSION

(Slide 10)

11. Primary controls and secondary controls are the most essential control systems for all types of aircraft. Several technology research and development efforts exist to integrate the functions of flight control systems such as ailerons, elevators, elevons, flaps, and flaperons into wings to perform the aerodynamic purpose with the advantages of less mass, lower cost, reduced drag and inertia (for faster, stronger control response).

FUSELAGE**(AF-2)**

Period	-	I
Type	-	Lecture
Year	-	II
Revised by	-	

Trg Aids

1. Computer slides, Pointer, Black board and chalk

Time Plan

2.	(a)	Introduction	-	05 mins
	(b)	Basic design and materials used	-	30mins
	(c)	Conclusion	-	05 mins
		Total		----- 40 mins -----

INTRODUCTION

(Slide 19)

1. Fuselage is the main body of the aircraft to which all the other components are attached. It also contains the cockpit from where the pilot controls the aero-plane. It provides the space for the freight and passengers.

AIM

(Slide 20)

2. To teach the cadets about basic design and materials used on fuselage.

PREVIEW

(Slide 21)

3. The class will be conducted in the following parts:-

- (a) Part I Basic design
- (b) Part II Materials used

BASIC DESIGN

(Slide 22-23)

4. The basic design of fuselage should satisfy the following:

- (a) Smooth skin of the required aerodynamic form.
- (b) Sufficient strength to withstand aerodynamic loads, landing loads and handling loads.
- (c) Sufficient stiffness to retain its correct shape under all loads.
- (d) Mounting points for engine, armament, fuel tanks and equipment.
- (e) Protection of aircrew and passengers from ambient conditions.
- (f) Sufficient break down points for easy dismantling for transportation and port- holes accessible for inspection and servicing.
- (g) Design itself should be economical and easy for production and repairs.

5. A basic fuselage layout is shown below for easy understanding. As can be seen, it comprises fire wall, wing attachment points, landing gear attachment points, stringers, bulk head/formers and stressed skin.

MATERIALS USED

Slide (24-25)

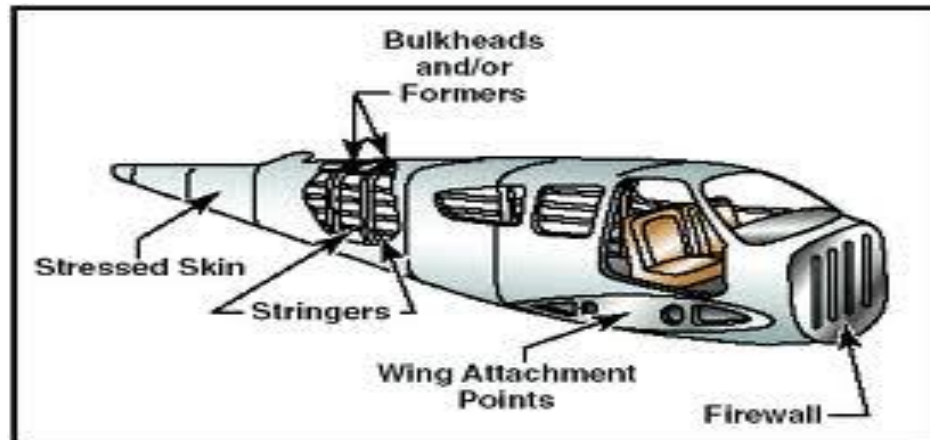

6. Early aircraft were constructed of wood frames covered in fabric. As monoplanes became popular, metal frames improved the strength, which eventually led to all-metal aircraft with metal covering all surfaces. Some modern aircraft are constructed with composite materials for major control surfaces, wings, or the entire fuselage such as the Boeing 787. On the 787, it makes possible higher pressurization levels and larger windows for passenger comfort as well as lower weight to reduce operating costs.

7. Hence the various types of materials can be classified as follows:

- (a) Wood
- (b) Metals
- (c) Composites

8. The various types of structures that are commonly used are as follows:

- (a) Stressed skin
- (b) Monocoque
- (a) D-spar construction
- (e) Box-spar

CONCLUSION

(Slide 26)

9. The fuselage is an aircraft's main body section that holds crew and passengers or cargo. In single-engine aircraft it will usually contain an engine, although in some amphibious aircraft the single engine is mounted on a pylon attached to the fuselage which in turn is used as a floating hull. The fuselage also serves to position control and stabilization surfaces in specific relationships to lifting surfaces, required for aircraft stability and maneuverability. Since fuselage is the main attachment point for fire wall,

wing attachment points, landing gear attachment points, stringers, bulk head/formers etc, its basic design and selection of materials play a major role in deciding the strength of fuselage. Hence designers are extremely cautious to study the aerodynamic effect on the given structure before going ahead with the type of structure suitable for a particular aircraft.

MAIN PLANE AND TAIL PLANE

(AF-3)

Period	-	II
Type	-	Lecture
Year	-	II
Revised by	-	

Trq Aids

1. Computer slides, Pointer, Black board and chalk

Time Plan

2.	(a)	Introduction	-	05 mins
	(b)	Function and Types of Main/Tail plane	-	30mins
	(c)	Conclusion	-	05 mins
		Total	-----	40 mins

INTRODUCTION

(Slide 27)

1. Fuselage is the main body of the aircraft to which all the other components are attached. It also contains the cockpit from where the pilot controls the aero-plane. It provides the space for the freight and passengers.

AIM

(Slide 28)

2. To teach the cadets about Types and function of Main and Tail plane of an aircraft.

PREVIEW

(Slide 29)

3. The class will be conducted in the following parts:-

- (a) Part I Function of Main plane
- (b) Part II Function of Tail plane
- (c) Part III Types of Main and Tail plane

MAIN PLANE

(Slide 30-32)

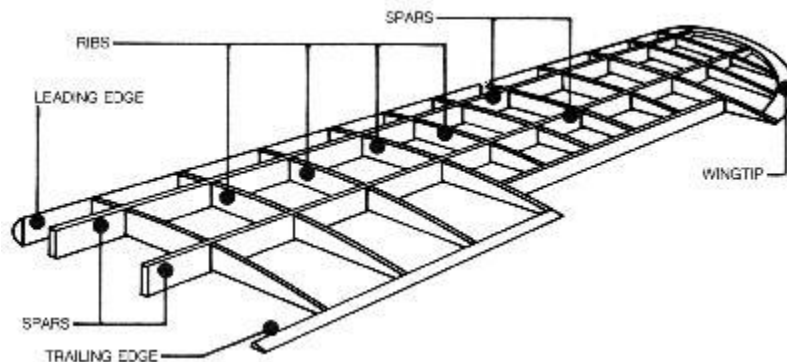

4. As shown in figure above, a wing is a type of fin with a **surface** that produces **lift** for **flight** or **propulsion** through the **atmosphere**, or through another **gaseous** or

liquid fluid. As such, wings have an **airfoil** shape, a **streamlined cross-sectional** shape producing a useful **lift to drag ratio**.

5. A wing's aerodynamic quality is expressed as its lift-to-drag ratio. The lift a wing generates at a given speed and angle of attack can be one to two orders of magnitude greater than the total drag on the wing.

6. There are various types of wings as shown in figure below. They are as follows:

- (a) Straight wing
- (b) Swept back wing
- (c) Delta wing
- (d) Tapered wing
- (e) Variable geometry wing



TAIL PLANE

(Slide 33-34)

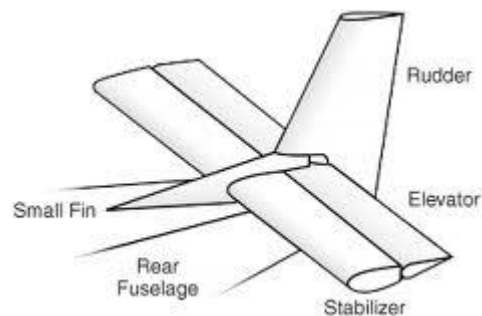

7. As shown in figure above, a tail plane, also known as horizontal **stabilizer** is a small **lifting** surface located on the tail (**empennage**) behind the main lifting surfaces of

a **fixed-wing aircraft** as well as other non-fixed wing aircraft such as **helicopters** and **gyroplanes**. The tail plane serves three purposes: equilibrium, stability and control.

8. There are various types of tail planes. They are as follows:

- (a) Cruciform Tail
- (b) T-Tail

9. The **cruciform tail** is an aircraft empennage configuration which, when viewed from the aircraft's front or rear, looks much like a cross. The usual arrangement is to have the horizontal stabilizer intersect the vertical tail somewhere near the middle, and above the top of the fuselage.

10. A **T-tail** is an empennage configuration in which the horizontal surfaces (tail plane and elevators) are mounted to the top of the vertical stabilizer. The resulting arrangement looks like the capital letter 'T' when viewed from the front or back, hence the name. This differs from the **traditional configuration in which the horizontal control surfaces are mounted to the fuselage at the base of the vertical stabilizer**.

CONCLUSION

(Slide 35)

11. Both Main plane and Tail plane play a major role in ensuring effective control of aircraft during its flight. The selection of Main and Tail plane is very crucial to ensure optimum stability and controllability to the aircraft.

AILERONS, ELEVATORS AND RUDDERS

(AF-4)

Period	-	I
Type	-	Lecture
Year	-	III
Revised by	-	

Trq Aids

1. Computer slides, Pointer, Black board and chalk

Time Plan

2.	(a)	Introduction	-	05 mins
	(b)	Ailerons, Elevators and Rudders	-	30mins
	(c)	Conclusion	-	05 mins
		Total		40 mins

INTRODUCTION

(Slide 36)

1. The main control surfaces such as Aileron and Elevators of a fixed-wing aircraft are attached to the airframe on hinges or tracks so that they may move and thereby deflect the air stream passing over them. This redirection of the air stream generates an unbalanced force to rotate the plane about the associated axis. The rudder is a fundamental control surface in order to provide means of controlling yaw of an airplane about its vertical axis.

AIM

(Slide 37)

2. To teach the cadets about Location and function of Ailerons, Elevators and Rudders.

PREVIEW

(Slide 38)

3. The class will be conducted in the following parts:-

- (a) Part I Aileron
- (b) Part II Elevator
- (c) Part III Rudders

AILERONS

(Slide 39-40)

4. The figure below shows the position of Aileron and Elevator on an aircraft.

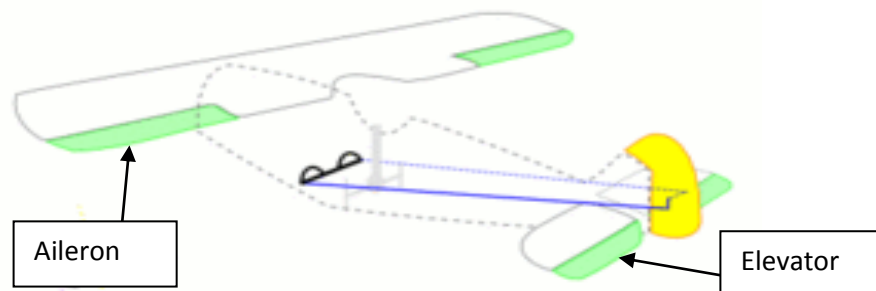

5. Ailerons are mounted on the trailing edge of each wing near the wingtips and move in opposite directions. When the pilot moves the stick left, or turns the wheel counter-clockwise, the left aileron goes up and the right aileron goes down. A raised aileron reduces lift on that wing and a lowered one increases lift, so moving the stick left causes the left wing to drop and the right wing to rise. This causes the aircraft to roll to the left and begin to turn to the left. Centering the stick returns the ailerons to neutral maintaining the bank angle. The aircraft will continue to turn until opposite aileron motion returns the bank angle to zero to fly straight.

ELEVATORS

(Slide 41-42)

6. An elevator is mounted on the trailing edge of the horizontal stabilizer on each side of the fin in the tail, as shown in the figure above. They move up and down together. When the pilot pulls the stick backward, the elevators go up. Pushing the stick forward causes the elevators to go down. Raised elevators push down on the tail and cause the nose to pitch up. This makes the wings fly at a higher angle of attack, which generates more lift and more drag. Centering the stick returns the elevators to neutral and stops the change of pitch. Many aircraft use a stabilator — a moveable horizontal stabilizer — in place of an elevator. Some aircraft, such as an MD-80, use a servo tab within the elevator surface to aerodynamically move the main surface into position. The direction of travel of the control tab will thus be in a direction opposite to the main control surface. It is for this reason that an MD-80 tail looks like it has a 'split' elevator system.

RUDDER

(Slide 43-46)

7. A typical view of Rudder is shown below.

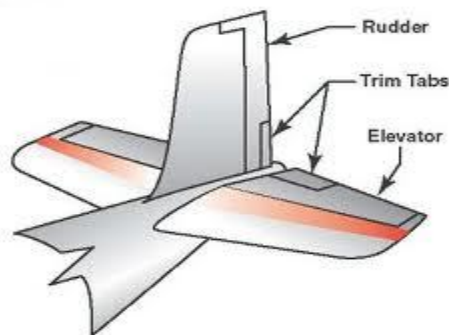

8. The **rudder** is a control surface, typically means of controlling yaw-the

fundamental controlled by is the primary rotation of an

airplane about its vertical axis. The rudder may also be called upon to counter-act the adverse yaw produced by the roll-control surfaces.

9. On an aircraft, the **rudder** is a directional control surface. The rudder is usually attached to the fin (or vertical stabilizer) which allows the pilot to control yaw about the vertical axis, i.e. change the horizontal direction in which the nose is pointing. The rudder's direction in aircraft has been manipulated with the movement of a pair of foot pedals by the pilot. In practice, both aileron and rudder control input are used together to turn an aircraft, the ailerons imparting roll, the rudder imparting yaw, and also compensating for a phenomenon called adverse yaw. A rudder alone will turn a conventional fixed wing aircraft, but much more slowly than if ailerons are also used in conjunction. Use of rudder and ailerons together produces co-ordinated turns, in which the longitudinal axis of the aircraft is in line with the arc of the turn, neither slipping (under-ruddered), nor skidding (over-ruddered).

CONCLUSION

(Slide 47)

7. On an aircraft, an **aileron** is a hinged flight control surface usually attached to the trailing edge of each wing of a fixed-wing aircraft. Ailerons are used in pairs to control the aircraft in roll, or movement around the aircraft's longitudinal axis, which normally results in a change in heading due to the tilting of the lift vector. Movement around this axis is called 'rolling' or 'banking'. **Elevators** are flight control surfaces, usually at the rear of an aircraft, which control the aircraft's orientation by changing the pitch of the aircraft, and so also the angle of attack of the wing. In simplified terms, they make the aircraft nose-up or nose-down. The elevators may be the only pitch control surface present which is hinged to a tail plane or horizontal stabilizer. Both **aileron** and **elevator** are important flight control surfaces and hence its design is very critical to flight safety. The **rudder** is a fundamental control surface, typically controlled by pedals. It is the primary means of controlling the rotation of an airplane about its vertical axis. The rudder may also be called upon to counter-act the adverse yaw produced by the roll-control surfaces.

LANDING GEAR

(AF-5)

Period	-	II
Type	-	Lecture
Year	-	I
Revised by	-	

Trg Aids

1. Computer slides, Pointer, Black board and chalk

Time Plan

2.	(a)	Introduction	-	05 mins
	(b)	Types of Landing gear and its requirements	-	30mins
	(c)	Conclusion	-	05 mins

Total				40 mins

INTRODUCTION

(Slide 11)

1. The **undercarriage** or **landing gear** in aviation is the structure that supports an aircraft on the ground and allows it to taxi, take-off and land. Typically wheels are used, but skids, skis, floats or a combination of these and other elements can be deployed, depending on the surface.

AIM

(Slide 12)

2. To teach the cadets about types of Landing gear and its requirements.

PREVIEW

(Slide 13)

3. The class will be conducted in the following parts:-
 - (a) Part I Types of Landing gear
 - (b) Part II Requirements of Landing gear

TYPES OF LANDING GEAR

(Slide 14-15)

4. A typical landing gear is shown below.



5. A **Landing gear** can be classified in to two types as follows:
- (a) **Fixed Landing gear.** A fixed gear always remains extended and has the advantage of simplicity combined with low maintenance. It produces parasitic drag in flight since it is not flush with the surface.
 - (b) **Retractable Landing gear.** To decrease drag in flight, some undercarriages retract into the wings and/or fuselage with wheels flush against the surface or concealed behind doors. This is called retractable gear. A retractable gear is designed to streamline the airplane by allowing the landing gear to be stowed inside the structure during cruising flight.

REQUIREMENTS OF LANDING GEAR

(Slide 16-17)

6. The landing gear is the principal support of the airplane when parked, taxiing, taking off, or landing. The most common type of landing gear consists of wheels, but airplanes can also be equipped with floats for water operations, or skis for landing on snow.
7. The landing gear consists of three wheels—two main wheels and a third wheel positioned either at the front or rear of the airplane. Landing gear with a rear mounted wheel is called conventional landing gear. Airplanes with conventional landing gear are sometimes referred to as tail wheel airplanes. When the third wheel is located on the nose, it is called a nose wheel, and the design is referred to as a **tricycle gear**. A steerable nose wheel or tail wheel permits the airplane to be controlled throughout all operations while on the ground. Most aircraft are steered by moving the rudder pedals, whether nose wheel or tail wheel. Additionally, some aircraft are steered by differential braking.
8. The Landing gear takes up the load of the aircraft while landing thereby prevent structural damage to the airframe.

9. A tricycle gear airplane has three advantages:
- (a) It allows more forceful application of the brakes during landings at high speeds without causing the aircraft to nose over.
 - (b) It permits better forward visibility for the pilot during takeoff, landing, and taxiing.
 - (c) It tends to prevent ground looping (swerving) by providing more directional stability during ground operation since the aircraft's center of gravity (CG) is forward of the main wheels. The forward CG keeps the airplane moving forward in a straight line rather than ground looping.

CONCLUSION

(Slide 18)

10. The landing gear forms the principal support of an aircraft on the surface. The most common type of landing gear consists of wheels, but aircraft can also be equipped with floats for water operations or skis for landing on snow. Since it is the primary load bearing member, its design is very crucial from the flight safety point of view.

CHAPTER – XI

INSTRUMENTS

BASIC FLIGHT INSTRUMENTS

(IN-1)

Period	-	I
Type	-	Lecture
Term	-	I
Revised by	-	

Trg Aids

1. Pointer, black- board, chalk, Computer slides, Multi Media Projector

Time Plan

2.	(a)	Intro	-	05 min
	(b)	Air Speed Indicator	-	10 min
	(c)	Altimeter	-	10 min
	(d)	Artificial Horizon	-	10 min
	(e)	Conclusion	-	05 min
		Total	-	40 min

INTRODUCTION

3. The best medium for flying an aircraft is the natural horizon. It is the place where the earth and the sky seem to meet. But during cloudy conditions and at night, the horizon is not visible. During such occasions, the instruments of an aircraft play a very vital role in aiding the pilot to fly the aircraft safely. As flying involves the third dimension, instruments become very important. The instruments also give out the health of the engine and re-assure the pilot that all vital parameters of flying are within the prescribed limits.

AIM

4. To introduce the NCC cadet to the basic six flying instruments used in flying an aircraft. This period will deal with three of those instruments viz, Altimeter, A/H and ASI.

AIR SPEED INDICATOR

5. The airspeed



indicator is an instrument

used in an aircraft to display the craft's airspeed to the pilot.

6. The principle of an Air Speed Indicator is the measurement of two pressures called static and pitot pressures.

7. If an open ended tube is moved through the air, pressure will be exerted at the closed end of the tube. This pressure has two components- static and the dynamic. The static pressure is due to the pressure exerted by the atmosphere and the dynamic is due to the movement of the tube through the air. The total pressure is known as pitot pressure. the dynamic pressure is indicated in terms of speed of the aircraft. The dynamic pressure is calculated as : $\text{Dynamic} = \text{Pitot} - \text{Static}$

I

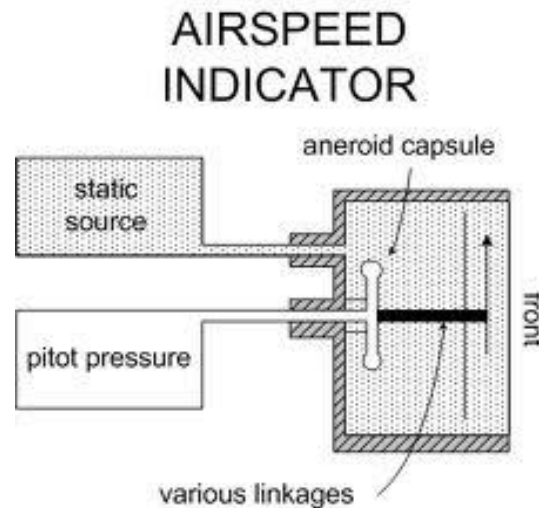

Internal mechanism of an airspeed indicator

8. This instrument uses an open ended capsule fixed inside an airtight case. The open end is connected to pitot pressure. Static pressure is fed inside the case. The static pressure remaining constant in the entire case, the variation is only in the pitot pressure due to the movement of the aircraft in air. The capsule accordingly expands or contracts and this variation is calibrated in terms of speed.

ALTIMETER

9. An altimeter is an instrument used to measure the altitude of an object above a fixed level usually the sea level. The altimeter shows the aircraft's altitude above mean sea-level. Altitude can be determined based on the measurement of atmospheric pressure.

10. The atmosphere has weight and this weight exerts pressure. This is known as static pressure. This pressure reduces with height at the rate of 1 millibar / hectapascal per 30 feet approximately.

11. An aneroid barometer is used to measure the atmospheric pressure. An aircraft altimeter is simply an aneroid barometer adapted to use in aircraft calibrated to read the atmospheric pressure in terms of height. This is done by measuring the difference between the pressure in a stack of aneroid capsules inside the altimeter and the atmospheric pressure obtained through the static system. As the aircraft ascends, the capsules expand and the static pressure drops, causing the altimeter to indicate a higher altitude. The opposite effect occurs when descending.

12. The altimeter has two or three capsules each having vacuum or partial vacuum in them. They are stacked together with one end fixed firmly down. There are three pointers to indicate height in 100s ,1000s and 10,000s feet.



13. The whole assembly is encased in a container having an inlet for the static pressure but otherwise is airtight. The movement of the capsules in response to the

variation in the pressure due to variation of height is transmitted to the pointers which indicate the height on the dial.

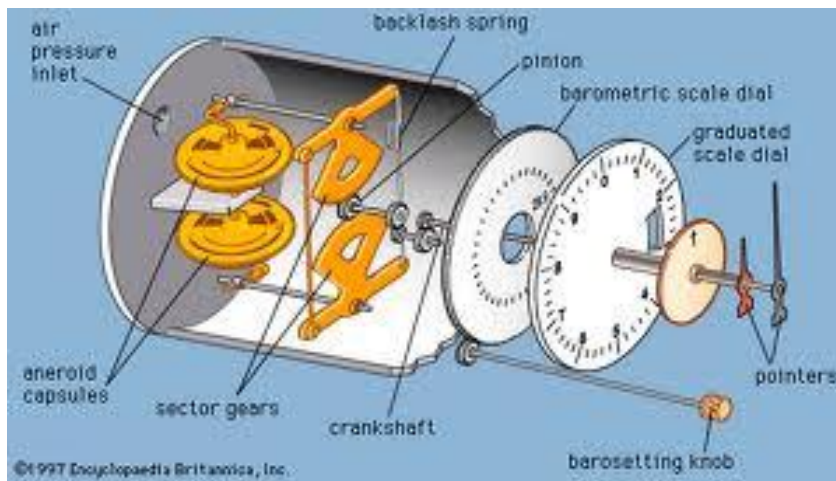

ARTIFICIAL HORIZON

14. The artificial horizon shows the aircraft's attitude relative to the horizon. From this, the pilot can tell whether the wings are level and if the aircraft nose is pointing above or below the horizon. This is a primary instrument for instrument flight and is useful in conditions of poor visibility.
15. An artificial horizon is an instrument used in an aircraft to inform the pilot of the orientation of the aircraft relative to earth. It indicates pitch (fore and aft tilt) and bank or roll (side to side tilt).
16. The essential components of the indicator are "miniature wings", horizontal lines with a dot between them representing the actual wings and nose of the aircraft:-
 - (a) The centre horizon bar separating the two halves of the display, with the top half usually blue in color to represent sky and the bottom half usually dark to represent earth.
 - (b) Degree marks representing the bank angle. They run along the rim of the dial. On a typical indicator, the first 3 marks on both sides of the center mark are 10 degrees apart. The next is 60 degrees and the mark in the middle of the dial is 90 degrees.
17. If the symbolic aircraft dot is above the horizon line (blue background) the aircraft is nose up. If the symbolic aircraft dot is below the horizon line (brown background) the aircraft is nose down. It is the horizon that moves up and down and turns, while the symbolic aircraft is fixed relative to the rest of the instrument panel.

18. Artificial Horizon uses a vertical axis earth gyroscope having freedom in all three planes to indicate the aircraft's attitude in pitch and roll. The gyroscope is geared to a display simultaneously displaying pitch and bank. The display is coloured to indicate the horizon as the division between the two coloured segments, blue for sky and brown for ground.



CONCLUSION

19. During this period, the basic three instruments have been covered to understand their use and functioning. One must remember that the instruments play a very vital part in helping the pilot to fly an aircraft. The height above the mean sea level, the condition of flight and the speed of the aircraft can thus be known by the pilot by monitoring the instruments.

INTRODUCTION TO RADARS**(IN-2)**

Period	-	I
Type	-	Lecture
Term	-	II
Revised by	-	

Trg Aids

1. Pointer, black- board, chalk, Computer slides, Multi Media Projector

Time Plan

2.	(a)	Intro	-	10 min
	(b)	RADAR	-	15 min
	(c)	Types of RADAR	-	10 min
	(d)	Conclusion	-	05 min
		Total	-	40 min

INTRODUCTION

1. Radar was secretly developed by several nations before and during World War II. The term RADAR was coined in 1940 by the United States Navy as an acronym for RADIO Detection and Ranging. The term radar has since entered English and other languages as the common noun radar, losing all capitalization.

2. The modern uses of radar are highly diverse, including air traffic control, radar astronomy, air-defence systems, antimissile systems; marine radars to locate landmarks and other ships; aircraft anti-collision systems; ocean surveillance systems, outer space surveillance systems; meteorological precipitation monitoring; and guided missile target locating systems.

AIM

3. The aim is to acquaint NCC cadets with RADARS and teach them the uses and application of radars in aviation.

RADAR

4. Radar is a machine that uses radio waves to find other objects such as aircraft, ships, and rain.

The basic parts of radar are:-

- (a) The transmitter creates the radio waves.
- (b) The antenna directs the radio waves.
- (c) The receiver measures the waves which are bounced back by the object that the radar is trying to find.
- (d) By doing this, the radar can find what place the object is at.

5. Radar is an object detection system which uses radio waves to determine the range, altitude, direction, or speed of objects. It can be used to detect aircraft, ships, spacecraft, guided missiles, motor vehicles, weather formations, and terrain. The radar dish or antenna transmits pulses of radio waves which bounce off any object in their path. The object returns a tiny part of the wave's energy to a dish or antenna which is usually located at the same site as the transmitter.

6. A radar system has a transmitter that emits radio waves called radar signals in predetermined directions. When these come into contact with an object they are usually reflected or scattered in many directions. Radar signals are reflected especially well by materials of considerable electrical conductivity—especially by most metals, by seawater and by wet lands. The radar signals that are reflected back towards the transmitter are the desirable ones that make radar work.

7. In aviation, aircraft are equipped with radar devices that warn of obstacles in or approaching their path and give accurate altitude readings.

TYPES OF RADARS

PRIMARY RADAR

8. This radar uses the principle of pulse technique to determine range and bearing of an object. Working on echo and search light principle, a transmitter transmits pulses. All objects in the path of the pulses will reflect and scatter this energy. Some of the reflected energy reaches the receiver. The reflected energy is processed to give the required information. In this radar, the object's cooperation is not required in the entire process.

SECONDARY RADAR

9. In this system, a transmitter transmits a group of pulses. An aerial in the path of the pulses receives the signals and passes it to receiver. If the pulses are identified, then the transmitter gives out a reply. In this radar active cooperation of the other object is also required.

CONTINUOUS WAVE RADAR

10. In this type of radar, both the transmission and the reception take place continuously. This requires set of two aerials, one for transmission and one for reception.

CONCLUSION

11. Thus it is seen that radar is used for locating objects by sending signals and receiving reflected signals. There are different kinds of radars. This equipment is used in various fields and especially so in the military field.

INSTRUMENT BATTERY TEST**(IN-3)**

Period	-	I
Type	-	Lecture
Term	-	III
Revised by	-	

Trg Aids

1. Pointer, black- board, chalk, model of an aircraft, roller charts of dial markings, Computer slides, Multi Media Projector

Time Plan

2.	(a)	Intro	-	10 min
	(b)	Altimeter	-	05 min
	(c)	A/H	-	10 min
	(d)	Compass	-	05 min
	(e)	ASI	-	05 min
	(d)	Conclusion	-	05 min
		Total	-	40 min

INTRODUCTION

3. Pilot aptitude battery test is administered once in a life time. It consists of two parts. The instrument battery test (INSB) and the machine test. Only the cadets who pass the INSB are then give an opportunity to give the machine test. This test is basically a test of understanding the readings of instruments, interpreting them and answering the multiple choice questions.

4. A typical simple aircraft has a nose, a tail or exhaust, a right wing and a left wing. It also has tail planes and a fin. Irrespective of the condition of flight and how one view the aircraft, the right wing is always referred to as right wing and the left as left wing. The nose is coloured white and the tail or exhaust is depicted by black colour. The reference of knowing whether an aircraft is climbing or descending is based on the position of the nose with respect to the horizon. If the nose is above the horizon, the a/c is climbing and it is descending when the nose is below the horizon. The a/c has a right bank if the right wing is below the horizon and a left bank when the left wing is below the horizon.

5. Instruments are required to fly an aircraft as you have already learnt in the first year. So this test of INSB is basically to know how to read and interpret the instruments. The first part of this test consists of reading six instruments and correlating it with five statements out of which only one is correct. The second part of the INSB consists of reading two instruments compass and A/H AND interpreting the correct position of an a/c from a set of five pictures given.

6. Part -I has only 15 questions numbered from 1-15 to be answered in 12 minutes. The part-II has 60 questions numbered from 16 to 75 to be answered in 20 minutes. The correct method of answering is by marking a cross, 'X', on the appropriate answer.

AIM

7. To acquaint the cadets with the INSB procedure followed at AFSBs.

ALTIMETER

8. A simple instrument which gives the altitude of aircraft in feet. The longer needle gives the altitude in hundreds of feet whereas the shorter needle gives the altitude in thousands of feet. The shorter needle jumps from one number to the next after the longer needle has completed one full revolution of 1000 feet. Unlike a watch the shorter needle does not have an intermediary position like that of an hour hand. The maximum altitude is only up to 9990 feet. Each division on the dial marks 20 feet. The position between two marks is to be interpreted as 10 feet.

ARTIFICIAL HORIZON

9. This instrument gives the bank angle, direction of bank, and the aircraft position viz, climbing descending, right wing low or left wing low. The dial has one stationary model of an aircraft which is going into the dial. That means we are able to see the tail of a/c. the wing towards our right is right wing and vice versa. There is one moving bar which is the artificial horizon bar. If the nose of the a/c is above the horizon bar, the a/c is in a climbing position and if below then it is in descending position. Whether the a/c is actually climbing or descending is given by another instrument called the rate of climb and descend indicator. If the right wing is below the horizon, the a/c is flying with right wing low with a certain bank. This bank angle is read out from the top part of the dial. A triangular mark will give the bank angle in a direction opposite to that of the bank. If the a/c is banking to the right, then the marker will indicate towards the left. Thus this instrument gives out the condition of flight. Whether A/c climbing descending or maintaining straight and level flight. Whether a/c has right or left wing low, the bank angle and also the instrument gives out a combination of these positions. This instrument has to be read in conjunction with ROCI and turn and bank indicator to actually know whether the a/c is climbing/descending or turning right/left.

COMPASS

10. The dial has markings of N, E, S, W directions. These are the cardinal headings north east south and west. At every 45° there is one marking giving the inter -cardinal headings north east, southeast, southwest and North West. There is one needle reading

the direction. If the needle is in the arc between north and north east the direction is read as north of north east. The needle being between north east and east is interpreted as east of north east. Similarly other directions are interpreted.

ASI

11. The dial has markings of speed in MPH or miles per hour. Each marking represents 10 mph. 40, 80, 120, etc are marked up to 240 mph. The least count is of 5 mph. There is a needle from which the readings are interpreted.

CONCLUSION

12. The understanding of the instruments and their readings would again be taught at the AFSBs before commencement of the test. This exposure at NCC will enable the cadets to imbibe the instructions better at the PABT centre. The first part of the INSB is to be continued in the next period where three more instruments will be covered.

CHAPTER – XII
AIRCRAFT PARTICULARS

AIRCRAFT PARTICULARS**(AP-1)**

Period	--	II
Type	--	Lecture
Term	--	I/I
Revised by	--	

Trg Aids

1. Computer slides, pointer, black board and chalk.

Time Plan

2.	(a)	Intro	-	05 mins
	(b)	Aircraft Particulars	-	30 mins
	(c)	Conclusion	-	05 mins
		Total	-	40 Mins

INTRODUCTION

(Slide 01)

3. The particulars of some of the aircraft are given in the subsequent paragraphs.

AIM

(Slide 02)

4. To know better knowledge about the different types Aircraft in use.

MIRAGE 2000

Role: Single Seater Air Combat.

Particulars:

Length/Span/Height--	14.5 / 9.0/ 3.4 Metres
Max Take-Off Weight--	16,500 Kgs
Fuel Capacity--	3800 + 2 X 1700 Litres(Drop Tanks)
Pay Load--	6000 Kgs(Four missiles + 2 X 20 mm DEFA guns)

Performance:

Max Speed--	Mach 2.35 at 11 Km altitude.
Range--	1480 Km
Engine (Thrust)--	One Turbo-fan (9700 kg)

Special Features

- Nine hard-points for pay load, two under each wing and five under fuselage, a rare feature of any combat aircraft.
- French design, inducted into IAF in 1987.

JAGUAR

Role: Deep penetration strike aircraft.

Particulars:

Length/Span/Height--	16.95 /8.7/ 4.8 Metres
Max Take-Off Weight--	15,700 Kgs
Fuel Capacity--	4200 + 3 X 1200 Litres(Drop Tanks)
Pay Load--	4,750 Kgs(2 X 30 mm ADEN guns)

Performance:

Max Speed--	1350 kmph.
Range--	3500 Km
Engine (Thrust)--	Two Turbojet (3810 kg each)

Special Features

- Seven hard-points, four under each wing, one under fuselage and two over wings(a unique feature).
- UK-France design, built under licence by HAL.

LIGHT COMBAT AIRCRAFT (LCA)

Role: Single Seater Multi Role Combat.

Particulars:

Length/Span/Height--	13.2 / 8.2/ 4.4 Metres
Max Take-Off Weight--	8,500 Kgs
Pay Load--	4000 Kgs(Beyond-Visual-Range missiles, Reconnaissance/Electronic Warfare pods and 23 mm GSH gun.

Performance:

- Single engine aircraft expected to be supersonic at all altitude.
- Small size will reduce its chances of detection by enemy radars.
- Capable of Take-off and landing from very short runways.
- Inertial navigation system for accurate navigation and guidance.
- In flight refuelling probe for extended range.

Special Features

- Once in the air, it shall be world's smallest light weight and highly manoeuvrable combat aircraft with seven hard-points.
- It is being developed by aeronautical development agency with contribution from more than 100 government/private agencies.

IL - 76

Role: Heavy Duty, Long Range Transport.

Particulars:

Length/Span/Height--	46.6 / 50.5/ 14.8 Metres
Max Take-Off Weight--	1,70,000 Kgs
Fuel Capacity--	51,300 Litres
Pay Load--	40,000 Kgs(upto 225 para-troopers)

Performance:

Cruise Speed--	850 Kmph
Range--	6,500 Km
Engine (Power)--	Four Turbo-fans (12000 Kg each)

Special Features

- Three IL-76 can airlift an entire infantry battalion with its equipment and ammunition across the sub-continent in a few hours. It carries 2 X 23 mm guns in the tail.

EMBRAER(135-BJ)

Role: Passenger version transport aircraft to carry the passengers.

Particulars:

Length/Span--	86.5 /68.92Metres
Fuel Capacity--	8314 Litres

Special Features:

- It can carry 19 passengers.

BOEING-737-200

Role: It is an American Transport aircraft used by the IAC on its internal routes in India to carry the passengers.

Particulars:

Length/Span/Height--	30.48 /28.35/ 11.28 Metres
Fuel Capacity--	26,026Litres
Pay Load--	15544 Kgs

Performance:

Max/Cruise Speed--	940/845 Kmph
Range--	3555 Km
Engine (Power)--	Two Pratt & Whitney Turbo-fans (6575 Kg)

Special Features

- It accommodates up to 119 passengers with a crew of two, or carries 15544kg of cargo in all cargo version.

KAMOV (Ka-25)

Role: Anti-Submarine warfare.

Particulars:

Length/Height--	9.75 / 5.37 Metres
Max Take-Off Weight--	7500 Kgs
Pay Load--	Dipping Sonar, Search radar, Air to Surface guided missiles.

Performance:

Cruise/Max Speed--	193/209 KMPH
Range--	400 Km
Engine (Thrust)--	Two Turbo shafts(900 hp each)

Special Features

- It does not have any tail rotor. Instead it has two sets of main rotor blades rotating in opposite direction.
- Main rotor blades can be folded for ease of storage.

MI-26

Role: Heavy Lift Helicopter.

Particulars:

Length/Height--	33.7 / 8.6 Metres
Max Take-Off Weight--	56000 Kgs
Pay Load--	20000 Kgs (70 Combat Troops)

Performance:

Cruise/Max Speed--	255/295 KMPH
Range--	800 Km
Engine (Thrust)--	Two Turbo shafts(11400 HP each)

Special Features

- Main rotor has eight blades and tail rotor has five blades.
- Normal crew of five consisting of pilot, co-pilot, flight engineer, navigator and load master.

MI-25

Role: Fighter Helicopter.

Particulars:

Length/Height--	17.50 / 6.5 Metres
Fuel Capacity--	2055 Litres

CHAPTER – XIII
AEROMODELLING

HISTORY OF AEROMODELLING (AM-1)

Period	--	I
Type	--	Lecture
Term	--	I/I
Revised by	--	

Trg Aids

1. Computer slides, pointer, black board and chalk.

Time Plan

2.	(a)	Intro	-	05 mins
	(b)	History of Aeromodelling	-	30 mins
	(c)	Conclusion	-	05 mins
		Total	-	40 Mins

"When once you have tasted flight, you will forever walk the earth with your eyes turned skyward, for there you have been, and there you will always long to return."
- Leonardo da Vinci

INTRODUCTION

(Slide 01)

3. Aeromodelling is one of the finest & costly hobbies, which is very popular worldwide among people of all ages and professions. It has often been the starting point of many pilot and aero-nautical engineer. The aims of including aeromodelling in the NCC curriculum are to increase the air mindedness in the youth of our country. If taken on the right lines, it can be extremely thrilling for all, as by constructing the models by one's own hands, will make understanding of various principles of flight and problems of construction etc., very easy, apart from providing great personal satisfaction to the aeromodeler.

AIM

(Slide 02)

4. To know better knowledge the history of aeromodelling and flying objects.

PREVIEW

(Slide 03)

5. The class will be conducted in the following parts:-
- (a) History of Aeromodelling

HISTORY OF AEROMODELLING

(Slide 04)

6. The history of aeromodelling goes back much further than the history of real aircraft. The successful experiments, however, started in the nineteenth century. Dr. Thomas Young was the first person to discover the 'lifting' property of a cambered surface in comparison to the flat surface. Sir George Caley built a helicopter model, based on a design of Leonardo-da-vinci, in 1796. Another aeromodelling genius was John String fellow, who built, in 1842, a small spring 'Operated model', followed by a number of different and bigger models, powered by 2-stroke as well as steam engines. Another great name amongst the pioneers of aeromodelling is of Alphones Penand, who invented models fitted with tail surfaces and wings with dihedral angles. This gave substantial stability of flight to aero models, which till this time had lasted for very short duration. Next came energy, enthusiasm and tenacity of purpose which earned him the distinction of being the most active champion of glider flying. After this, came the era of miniature petrol-driven engines. In 1878, Professor Langley builds a petrol driven model called 'Aerodrome No.5'. This revolutionised the concept of aeromodelling, as there was now an ideal power plant small enough for the requirement, available to the enthusiasts. Hundreds of varieties of petrol models were subsequently built. Later, these gave ways to more powerful diesel engines, which are in use even today.

CONCLUSION

(Slide 05)

The 'aeromodelling' provides an earnest approach to the understanding of an otherwise highly technical subject, i.e. 'aerodynamics'. The 'air-minded' aeromodeller of today is the potential aircraft designer of tomorrow. Although, aeromodelling is a technical hobby and is usually cluttered up with complicated calculations and formulae, it need not necessarily discourage the beginners and the non-technical persons, as they can still derive immense pleasure and satisfaction from this hobby. Aeromodelling is becoming increasingly popular all over the country especially amongst the NCC Air wing cadets.

MATERIALS USED IN AEROMODELLING

(Slide 04)

6. The following are the main substances from which the Aeromodels can be made:

- i. Balsa Wood
- ii. Spruce
- iii. Japanica Wood
- iv. Ply wood
- v. Cement
- vi. Fast Setting Epoxy
- vii. Cyanoacrylate Glue (Cyano)
- viii. Putty
- ix. Metal paste
- x. Dope
- xi. Paint
- xii. Sand paper
- xiii. Fiber glass
- xiv. Carbon Fiber
- xv. Silver Foil
- xvi. Monokote& etc..

Basic tools

- i. Screw driver
- ii. Hand drill
- iii. Sand paper and pins
- iv. Pliers
- v. Knives with different blades
- vi. Different kind of saw
- vii. Files
- viii. Soldering irons
- ix. RC set (Transmitter, Receiver, Servos) etc.

CONCLUSION

(Slide 05)

After selection of good materials and required tools one has to handle these tools carefully. Mishandling of tools may cause serious injuries to the Aeromodellers/builders.

TYPES OF AEROMODELS(AM-3)

Period	--	I
Type	--	Lecture
Term	--	I/III
Revised by	--	

Trg Aids

1. Computer slides, pointer, black board and chalk.

Time Plan

2.	(a)	Intro	-	05 mins
	(b)	Types of Aeromodel	-	30 mins
	(c)	Conclusion	-	05 mins
		Total	-	40 Mins

“It is possible to fly without motors, but not without knowledge and skill.”- Wilbur Wright

INTRODUCTION

(Slide 01)

3. There are quite a number of variants of aeromodels, which are classified according to the role and utility of the particular type. These are static models, gliders, control line models and RC models.

AIM

(Slide 02)

4. To have a different experimental approach and excavate different aerodynamic models on flying objects.

PREVIEW

(Slide 03)

5. The class will be conducted in the following parts:-

- (a) Types of Aeromodelling

TYPES OF AEROMODELLING

(Slide04)

The following are the different type of Aeromodels.

6. **Static Modes**:-These are the miniature replicas of original aircrafts. The following aircrafts can be prepared as static models.
 - i. Fighter aircraft models
 - ii. Transport aircraft models
 - iii. Helicopter models

7. **Gliders**: - These are the different types of gliders:-
 - (i) Chuck Glider
 - (ii) Catapult Glider
 - (iii) Towline Glider
 - (iv) Free flight Glider

8. **Control Line Models**: -The following are the different types of Control Line model:-
 - (i) Control Line Aerobatic Model
 - (ii) Control Line Speed Model

9. **Radio control Models**: -The following are the different types of Control Line model:-
 - (i) Radio Control Power
 - (ii) Radio Control Glider
 - (iii) Radio control Helicopter
 - (iv) Jet Powered Model

CONCLUSION

(Slide 05)

Building and flying the different types of models would help the aero modeler to improve their aerodynamic knowledge and skills.

FLYING/BUILDING OF AEROMODELS**(AM-4)**

Period	--	I
Type	--	Lecture
Term	--	I/II, II/VI, III/IX
Revised by	--	

Trg Aids

25. Computer slides, pointer, black board and chalk.

Time Plan

2.	(a)	Intro	-	05 mins
	(b)	Flying / Building of Aero Models	-	30 mins
	(c)	Conclusion	-	05 mins

		Total	-	40 Mins

“What is chiefly needed is skill rather than machinery.”- Wilbur Wright

INTRODDUCTION

(Slide 01)

3. Individual personally required to build or construct the models by given design or own design and fly the models by using Fly By Wire / Radio Control set.

AIM

(Slide 02)

4. Practical knowledge of building and flying the models.

PREVIEW

(Slide 03)

5. The class will be conducted in the following parts:-

- (a) Construction of Static Models
- (b) Construction of control line Models

- (c) Construction of remote control Models
- (d) Flying the Models

CONSTRUCTIONS OF STATIC MODELS

(Slide 04)

6. These are the miniature replicas of original aircrafts, full sized aircraft types and attract the best skill of the model maker. The scope of this particular type is boundless and depends upon the ideas of the individual concerned. It requires only an elementary knowledge of carpentry and involves fitting together of various parts as well as finishing and painting of the models.

7. Constructions plans are provided normally with all model kits. These should be studied thoroughly. Then follow the shaping of various parts using sandpaper and sand blocks as shown in the blue print. After which the whole plan is fixed on the drawing board. Then the individual parts are placed on the blue print and make sure it is proper as per the blue print. Parts are then assembled together as per the dimensions provided in the blue print. Dope is applied with brush but only in thin coats two to three times. Sand the excess dope using a fine emery paper.

8. **Painting:** - Apply a coat of surfacer using a brush or spray gun and make sure it has covered all the wooden area. After the surfacer is dried up check for dents and apply putty or metal paste to cover the dents. After it dries up using a wet emery paper, sand the model to get a clean surface till it is suitable for painting. Etch rivet marking as shown in the blue print. Spray a thin layer of base coat and paint the model as per the required colour scheme. Add details, undercarriage, wheels, drop tanks etc& apply lacquer or polish if required.

9. **Demo and Practical**

CONCLUSION

The construction/building of static models is one of the main event in all India level competitions like AIVSC and RDC. In AIVSC, the given static model has to be built in stipulated time and for RDC competition, three different static models have to be built that is fighter, transport and helicopter.

CONSTRUCTIONS OF CONTROL LINE MODELS (Slide 05)

10. Each and every part of a model aero plane is important as it would not function in the absence of even one component. Construction plans are provided normally with all model kits. These should be studied thoroughly. Then follows the actual construction of various parts. The power units are, also available in readymade forms, and are required to be installed as they are, as per the power/weight combination prescribed by the manufactures

11. First, the whole plan is fixed on to the drawing board. Then the individual parts are fixed on it with the help of pins parts are then glued together with cement. After drying, the various components are assembled together with correct alignment. Sand papers of various grades are used for smoothening out of edges and curves. Patience and meticulous operation is needed at this point. Assemble the bell crank assembly with the lead outs carefully. Model is then covered with sliver foil, monokote or tissue paper. Dope may be applied with brush, in thin coats two to three times.

12. Before engine installation, ensure that the engine compartment is properly treated with paint work. While installing the engine, extreme care is needed to be taken to ensure that the thrust line of the propeller is in line with the fuselage. Out of line thrust will result in the model going hay wire and crashing. Engines are mounted either by projection made of hard wood beams or on screws against the plywood.

13. **Demo and Practical**

CONCLUSION

The construction of control line model is slightly advanced as compared to tow line glider and free flight models. In this model, there is only one control surface for most control line aircraft; the up and down movement of the elevator on the stabilizer. The rudder is set so the aircraft will always pull away from the flier (to help keep the control line taut)

CONSTRUCTIONS OF REMOTE CONTROL MODELS (Slide 06)

14. Each and every part of a model aero plane is important as it would not function in the absence of even one component.

15. Construction plans are provided normally with all model kits. These should be studied thoroughly. Then follows the actual construction of various parts. The power units are, also available in readymade forms, and are required to be installed as they are, as per the power/weight combination prescribed by the manufactures.

16. First, the whole plan is fixed on to the drawing board. Then the individual parts are fixed on it with the help of pins parts are then glued together with cement. After drying, the various components are assembled together with correct alignment. Sand papers of various grades are used for smoothening out of edges and curves. Patience and meticulous operation is needed at this point. Model is then covered with sliver foil, monokote or tissue paper. Dope may be applied with brush, in thin coats two to three times.

17. Before engine installation, ensure that the engine compartment is properly treated with paint work. While installing the engine, extreme care is needed to be taken to ensure that the thrust line of the propeller is in line with the fuselage. Out of line thrust

will result in the model going hay wire and crashing. Engines are mounted either by projection made of hard wood beams or on screws against the plywood.

18. Install the Radio-control servos as per the requirement to make sure the control rods should move freely without causing any disturbance to the other control rods. Wrap the receiver and the battery pack in foam and place it in the model in such a way that the CG of the model is correct as per the marking shown in the plan by the manufacturer of the kit. Then assemble the wing using a pairs of rubber bands or nylon screws.

19. **Demo and Practical**

CONCLUSION

This type of model is fitted with radio receiver sets of actuators operate the control surfaces of the model. The radio receiver receives signal from the control box which is operated by the "pilot". The control box is nothing, but a transmitter with various channels for operating the respective controls including throttle. This way, the model can be operated without physical contact.

FLYING THE MODELS

(Slide 07)

20. The necessity of choosing a large field for flying the aero models is obvious. However, trees and wooded areas are the greatest hazards for the aeromodeller. Trees cause air pockets and down-draughts and often 'suck' the model into their branches.

21. First check the model for correction of alignment. The wing and tail must be checked from the front and rear for setting and must not be warped or out of plane. Testing is carried out during mid-day when there is little or no wind. The model is held on the point of balance i.e. approximately $1/3^{\text{rd}}$ back from leading edge of the wing, and is gently launched into wind slightly nose down attitude. If the model is set properly and trimmed correctly, it will glide forward gracefully and will land on wheels. Use plasticine or lead weight at the nose and tail for balance as required.

22. Power flight is not advisable till the gliding test is carried out successfully. For trail flight, a small amount of fuel is put into the fuel tank and the engine started by rotating the propeller. And the model launched gently the model should fly short distance and land perfectly.

23. **Demo and practical (Models and field equipment)**

SAFETY CODE

GENERAL

- (i) I will not fly my model aircraft in competition or in the presence of spectators until it has been proven to be airworthy by having been previously successfully flight tested.
- (ii) I will not fly my model higher than approximately 400 feet within 3 miles of an airport without notifying the airport operator. I will give right of way to, and avoid flying in the proximity of full scale aircraft. Where necessary an observer shall be utilized to supervise flying to avoid having models fly in the proximity of full scale aircraft.
- (ii) Where established, I will abide by the safety rules for the flying site I use, and I will not willfully and deliberately fly my models in a careless, reckless, and/or dangerous manner.

RADIO CONTROL

- (i) I will have completed a successful radio equipment ground range check before the first flight of a new or repaired model.
- (ii) I will not fly my model aircraft in the presence of spectators until I become a qualified flyer, unless assisted by an experienced helper.
- (iii) I will perform my initial turn after takeoff away from the pit, spectator, and parking areas, and I will not thereafter perform maneuvers, flights of any sort, or landing approaches over a pit, spectator, or parking area.

CONTROL LINE

- (i) I will subject my complete control system (including safety thong, where applicable) to an inspection and pull test prior to flying.
- (ii) I will assure that my flying area is safety clear of all utility wires or poles.
- (iii) I will assure that my flying area is safely clear of all non-essential participants and spectators before permitting my engine to be started.

CONCLUSION

The individual has to undergo practically in Aeromodelling workshop to build and in flying field to fly the models